



SPOŁECZNA INICJATYWA
MIESZKANIOWA
ZAGŁĘBIE



WOJKOWICE

WYKAZ LOKALI MIESZKALNYCH

Wojkowice, ul. Sucharskiego





SPIS TREŚCI

01 Opis inwestycji

02 Jak korzystać z dokumentu?

03 Mieszkania 1-17

04 Mieszkania 18-34

05 Mieszkania 35-51

OPIS INWESTYCJI

Spółka SIM Zagłębie we współpracy z gminą Wojkowice realizuje inwestycję mieszkaniową zlokalizowaną przy ulicy Sucharskiego.

Powstanie w sumie 51 lokali mieszkalnych o powierzchni od 35 m² do 87 m².

Cztery mieszkania są przystosowane do potrzeb osób z niepełnosprawnością (nr 14, 15, 24, 34).

JAK KORZYSTAĆ Z DOKUMENTU?

Każde mieszkanie ma swój numer (1-51). Numer ten będzie potrzebny do wpisania we wniosku o najem mieszkania.

Przykładowo: chcąc zobaczyć specyfikację mieszkania nr 1, należy przejść do tabeli i odszukać mieszkanie nr 1.

Numer jest odnośnikiem do karty danego mieszkania.

NR	PIĘTRO	METRAŻ	POKOJE
<u>1</u>	0	35.13 m ²	2
<u>2</u>	0	70.33 m ²	4
<u>3</u>	0	70.61 m ²	3
<u>4</u>	0	34.98 m ²	2
<u>5</u>	0	35.47 m ²	2
<u>6</u>	0	35.63 m ²	2
<u>7</u>	0	52.33 m ²	3
<u>8</u>	0	52.64 m ²	3
<u>9</u>	1	35.50 m ²	2
<u>10</u>	1	71.09 m ²	4
<u>11</u>	1	71.20 m ²	3
<u>12</u>	1	35.28 m ²	2
<u>13</u>	1	35.80 m ²	2
<u>14 NP*</u>	1	71.00 m ²	3
<u>15 NP*</u>	1	71.00 m ²	3
<u>16</u>	1	35.93 m ²	2
<u>17</u>	1	53.37 m ²	3

*mieszkanie przystosowane do potrzeb osób z niepełnosprawnością



NR	PIĘTRO	METRAŻ	POKOJE
<u>18</u>	1	53.68 m ²	3
<u>19</u>	2	35.50 m ²	2
<u>20</u>	2	71.09 m ²	4
<u>21</u>	2	71.20 m ²	3
<u>22</u>	2	35.28 m ²	2
<u>23</u>	2	35.80 m ²	2
<u>24 NP*</u>	2	71.00 m ²	3
<u>25</u>	2	71.00 m ²	3
<u>26</u>	2	35.93 m ²	2
<u>27</u>	2	53.37 m ²	3
<u>28</u>	2	53.68 m ²	3
<u>29</u>	3	35.50 m ²	2
<u>30</u>	3	71.09 m ²	4
<u>31</u>	3	71.20 m ²	3
<u>32</u>	3	35.28 m ²	2
<u>33</u>	3	35.80 m ²	2
<u>34 NP*</u>	3	71.00 m ²	3

*mieszkanie przystosowane do potrzeb osób z niepełnosprawnością



NR	PIĘTRO	METRAŻ	POKOJE
<u>35</u>	3	71.00 m ²	3
<u>36</u>	3	35.93 m ²	2
<u>37</u>	3	53.37 m ²	3
<u>38</u>	3	53.68 m ²	3
<u>39</u>	4	74.49 m ²	2
<u>40</u>	4	64.89 m ²	2
<u>41</u>	4	69.52 m ²	2
<u>42</u>	4	62.90 m ²	2
<u>43</u>	4	62.24 m ²	2
<u>44</u>	4	68.47 m ²	2
<u>45</u>	4	70.35 m ²	2
<u>46</u>	4	74.51 m ²	2
<u>47</u>	4	60.43 m ²	3
<u>48</u>	4	87.12 m ²	2
<u>49</u>	4	73.67 m ²	2
<u>50</u>	4	53.37 m ²	3
<u>51</u>	4	53.68 m ²	3

*mieszkanie przystosowane do potrzeb osób z niepełnosprawnością



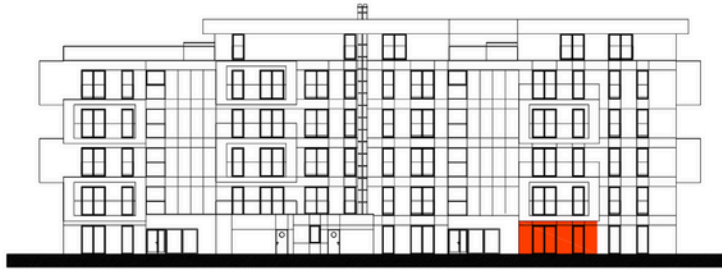
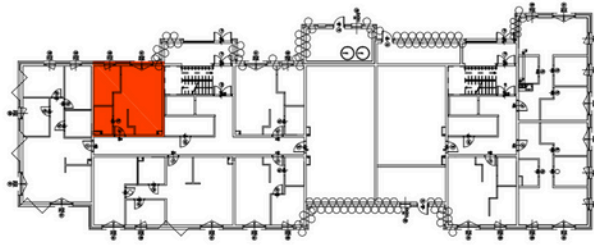

MIESZKANIE NR 1

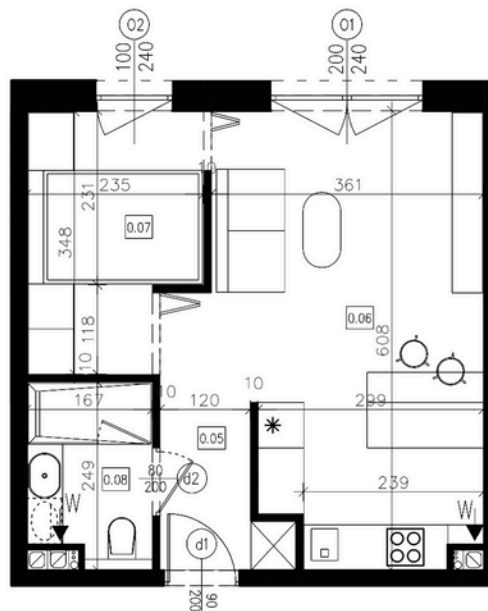

0.05	PRZEDPOKÓJ	3,05	POW. UŻYTKOWA 35,13 M ²
0.06	SALÓN Z KUCHNIĄ	20,89	
0.07	POKÓJ	7,30	
0.08	ŁAZIENKA	3,89	



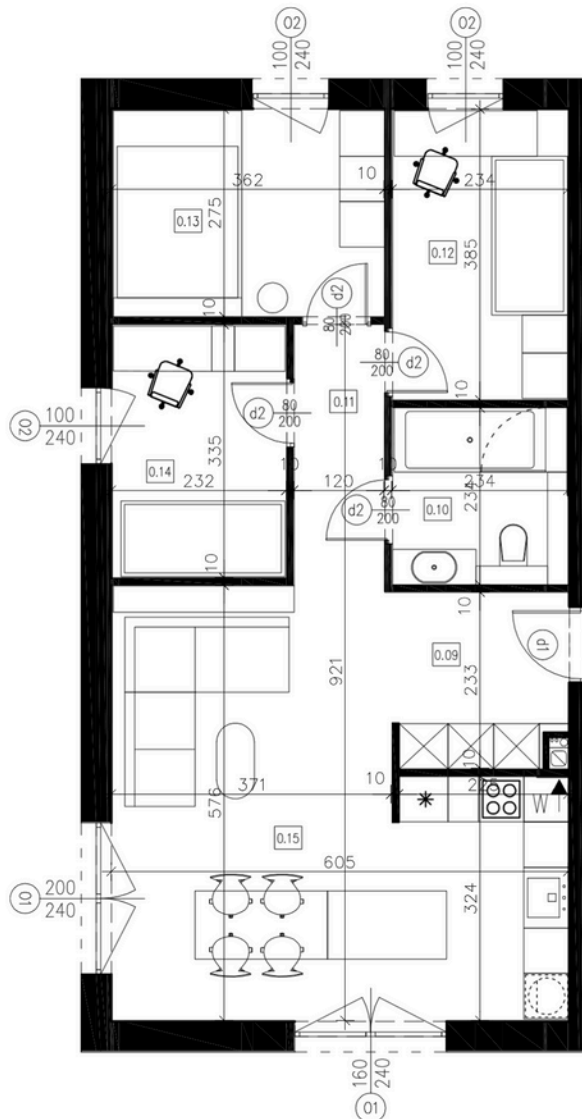
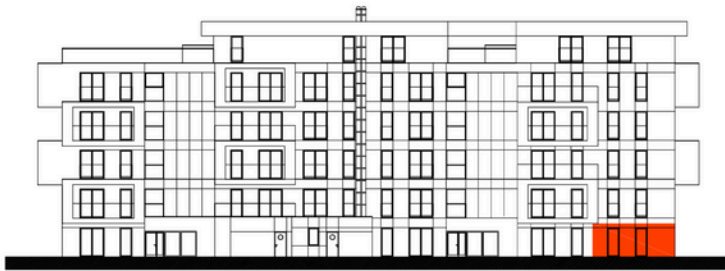
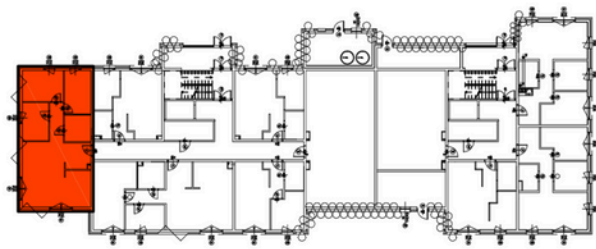

MIESZKANIE NR 2

0.09	PRZEDPOKÓJ	5,24	POW. UŻYTKOWA 70,33 M2
0.10	ŁAZIENKA	5,46	
0.11	PRZEDPOKÓJ	4,25	
0.12	POKÓJ	8,98	
0.13	POKÓJ	9,92	
0.14	POKÓJ	7,75	
0.15	SALON Z KUCHNIĄ	28,73	



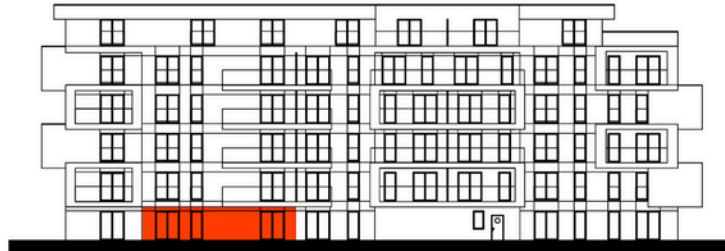
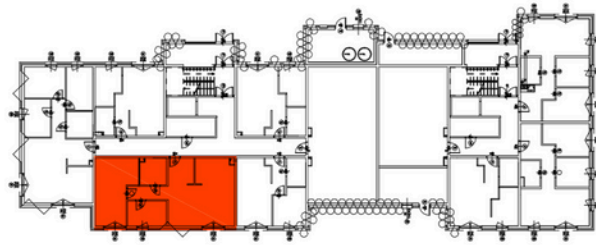

MIESZKANIE NR 3

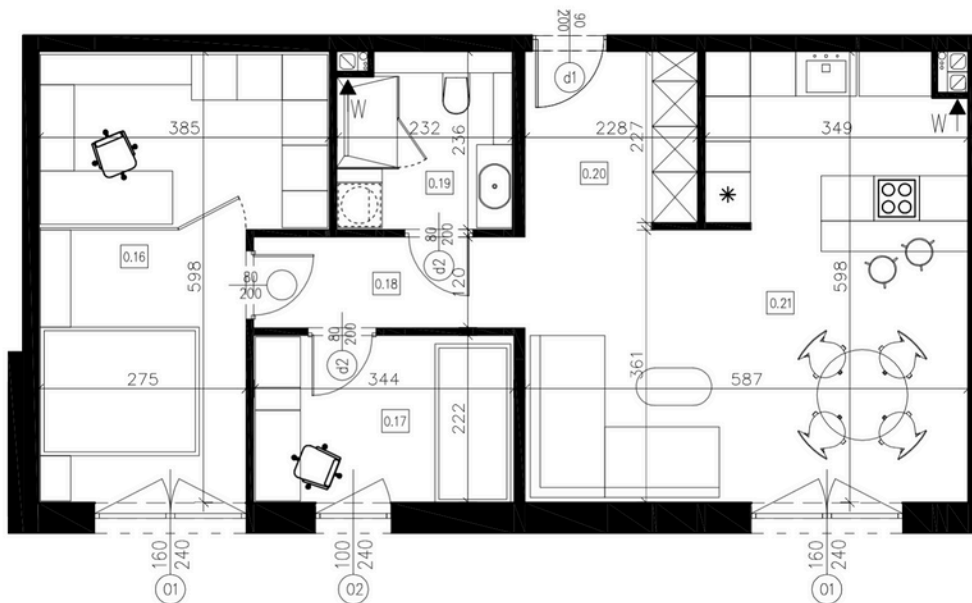

0.16	POKÓJ	19,00	POW. UŻYTKOWA 70,61 M ²
0.17	POKÓJ	7,62	
0.18	PRZEDPOKÓJ	4,30	
0.19	ŁAZIENKA	5,31	
0.20	PRZEDPOKÓJ	5,34	
0.21	SALON Z KUCHNIĄ	29,04	



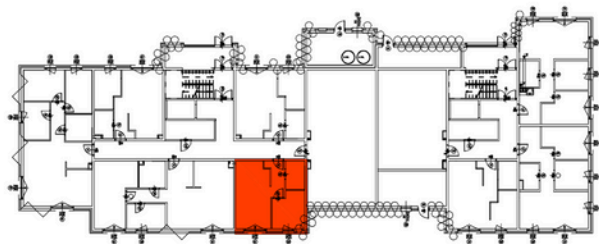

MIESZKANIE NR 4

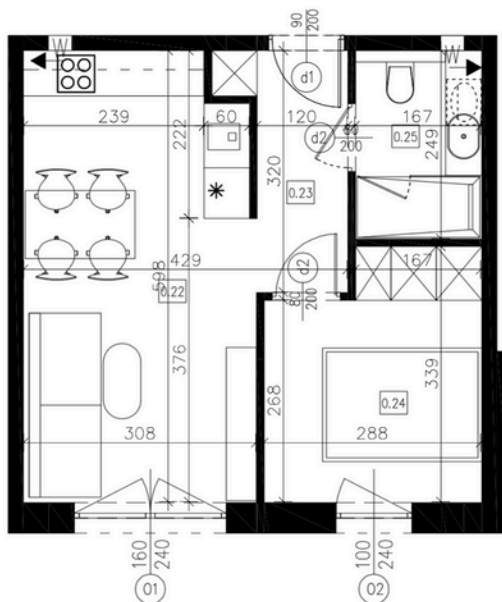

0.22	SALON Z KUCHNIĄ	17,76	POW. UŻYTKOWA 34,98 M2
0.23	PRZEDPOKÓJ	4,20	
0.24	POKÓJ	8,87	
0.25	ŁAZIENKA	4,15	



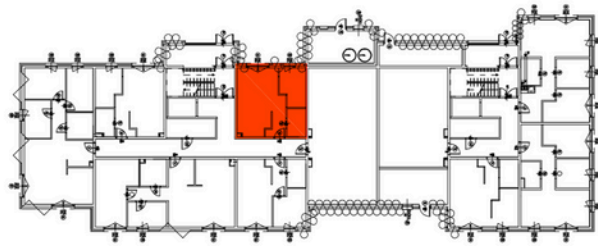

MIESZKANIE NR 5

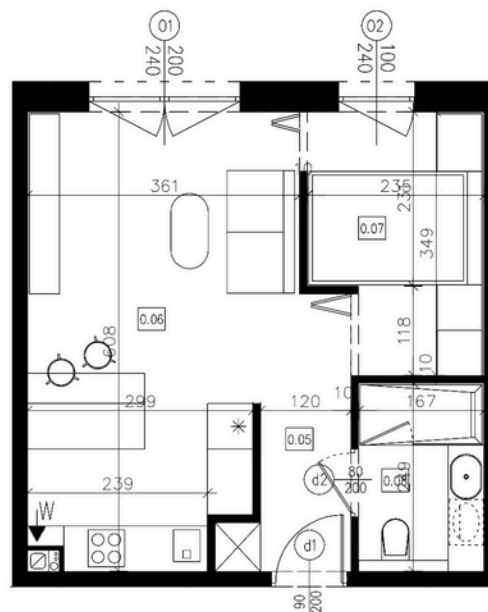

0.05	PRZEDPOKÓJ	3,05	POW. UŻYTKOWA 35,47 M ²
0.06	SALON Z KUCHNIĄ	20,90	
0.07	POKÓJ	7,37	
0.08	ŁAZIENKA	4,15	



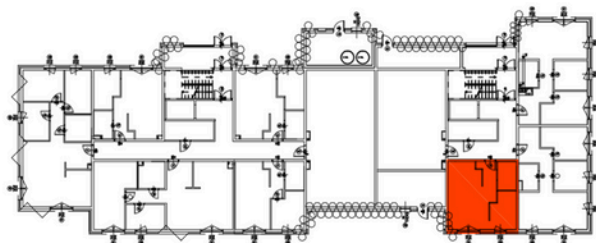

MIESZKANIE NR 6

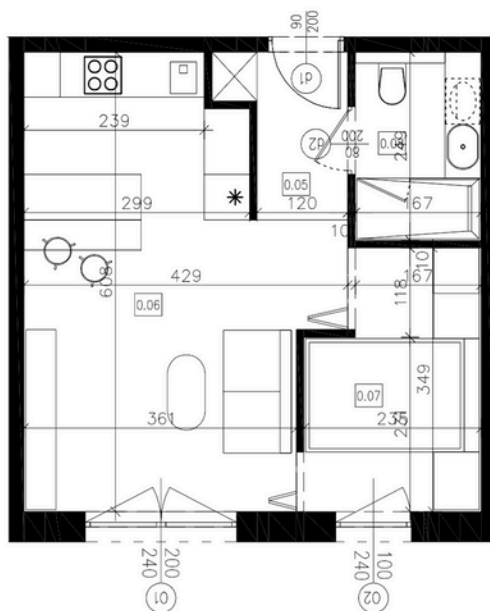

0.05	PRZEDPOKÓJ	3,05	POW. UŻYTKOWA 35,63 M2
0.06	SALON Z KUCHNIĄ	21,06	
0.07	POKÓJ	7,37	
0.08	ŁAZIENKA	4,15	



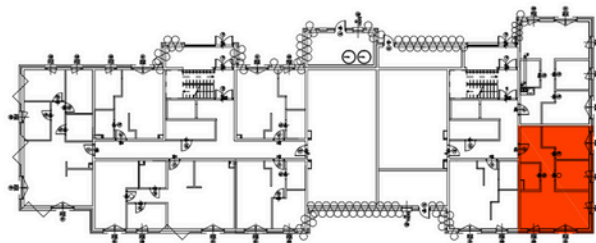

MIESZKANIE NR 7

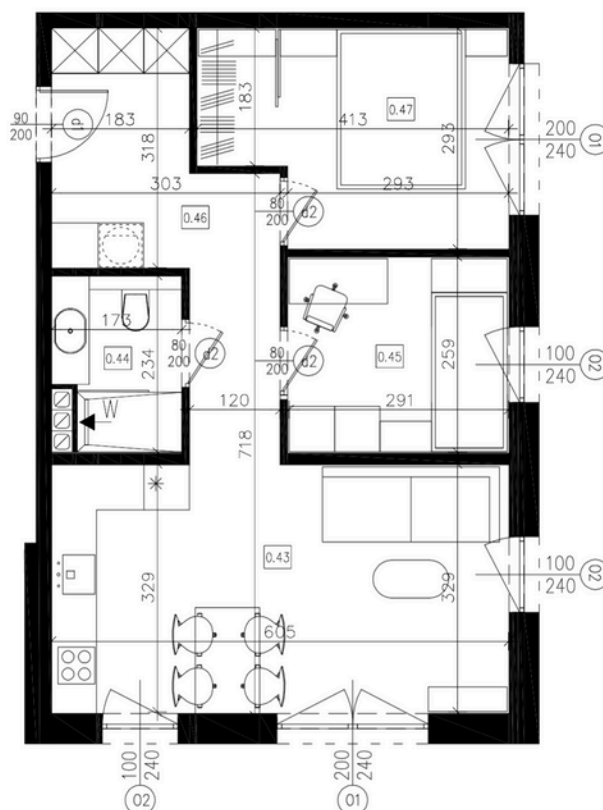

0.43	SALON Z KUCHNIĄ	19,87	POW. UŻYTKOWA 52,33 M2
0.44	ŁAZIENKA	3,73	
0.45	POKÓJ	7,58	
0.46	PRZEDPOKÓJ	10,40	
0.47	POKÓJ	10,75	



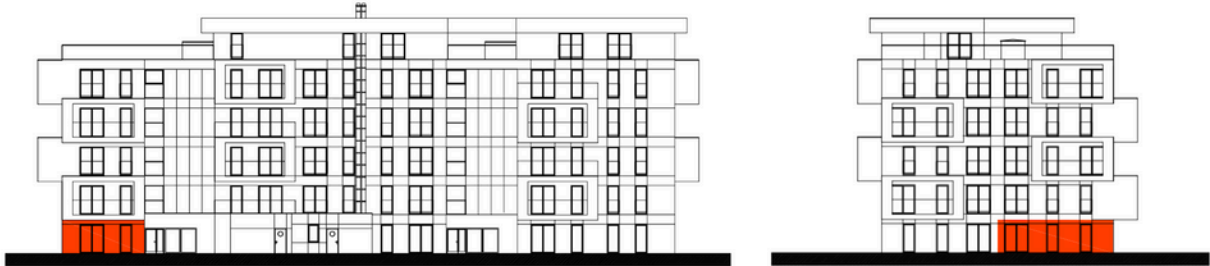
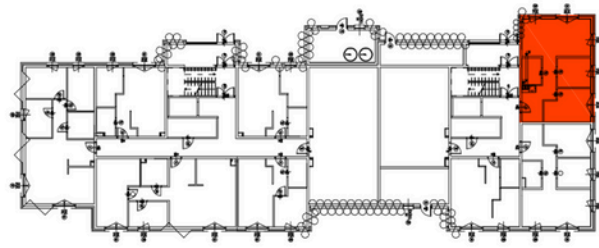

MIESZKANIE NR 8

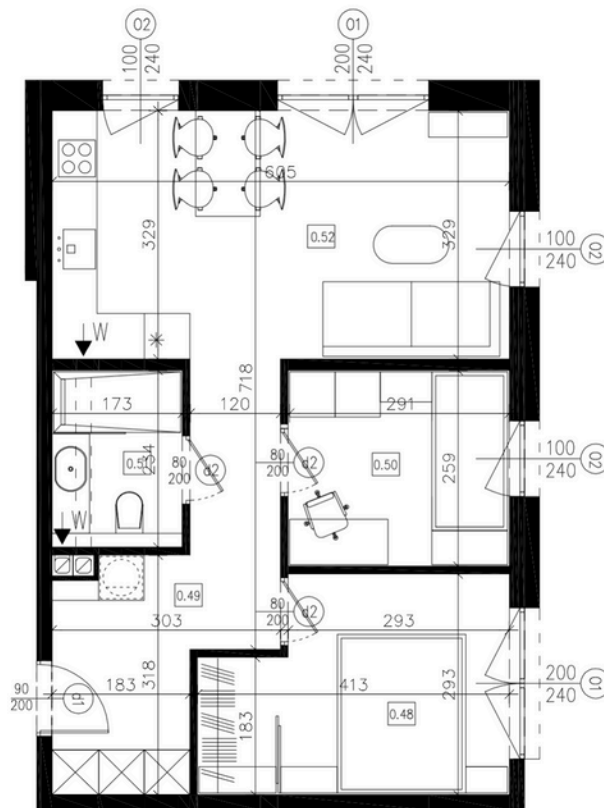

0.48	POKÓJ	10,75	POW. UŻYTKOWA 52,64 M ²
0.49	PRZEDPOKÓJ	10,40	
0.50	POKÓJ	7,58	
0.51	ŁAZIENKA	4,04	
0.52	SALON Z KUCHNIĄ	19,87	

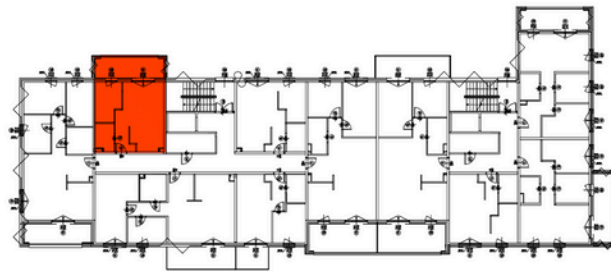

MIESZKANIE NR 9

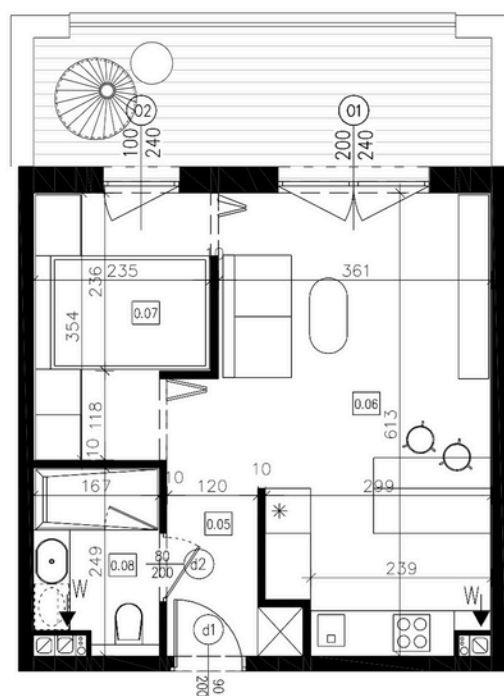

0.05	PRZEDPOKÓJ	3,05	POW. UŻYTKOWA 35,50 M2
0.06	SALON Z KUCHNIĄ	21,07	
0.07	POKÓJ	7,49	
0.08	ŁAZIENKA	3,89	



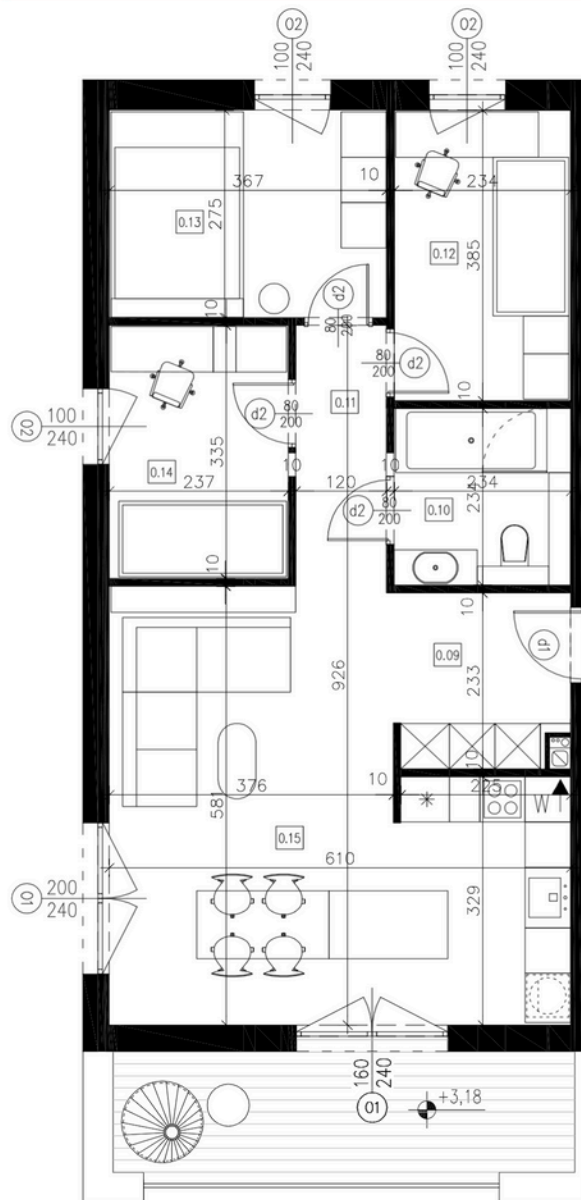
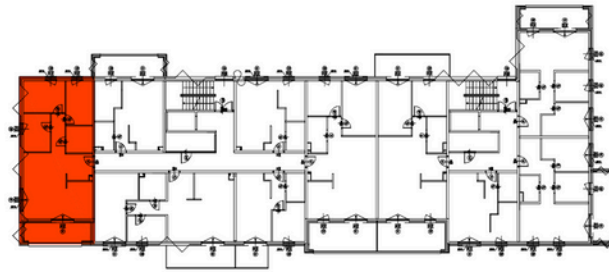

MIESZKANIE NR 10

0.09	PRZEDPOKÓJ	5,24	POW. UŻYTKOWA 71,09 M ²
0.10	ŁAZIENKA	5,46	
0.11	PRZEDPOKÓJ	4,25	
0.12	POKÓJ	8,98	
0.13	POKÓJ	10,06	
0.14	POKÓJ	7,92	
0.15	SALON Z KUCHNIĄ	29,18	



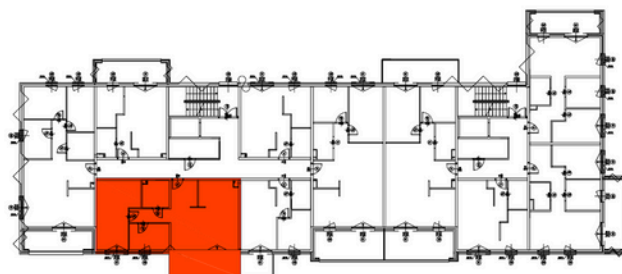

MIESZKANIE NR 11

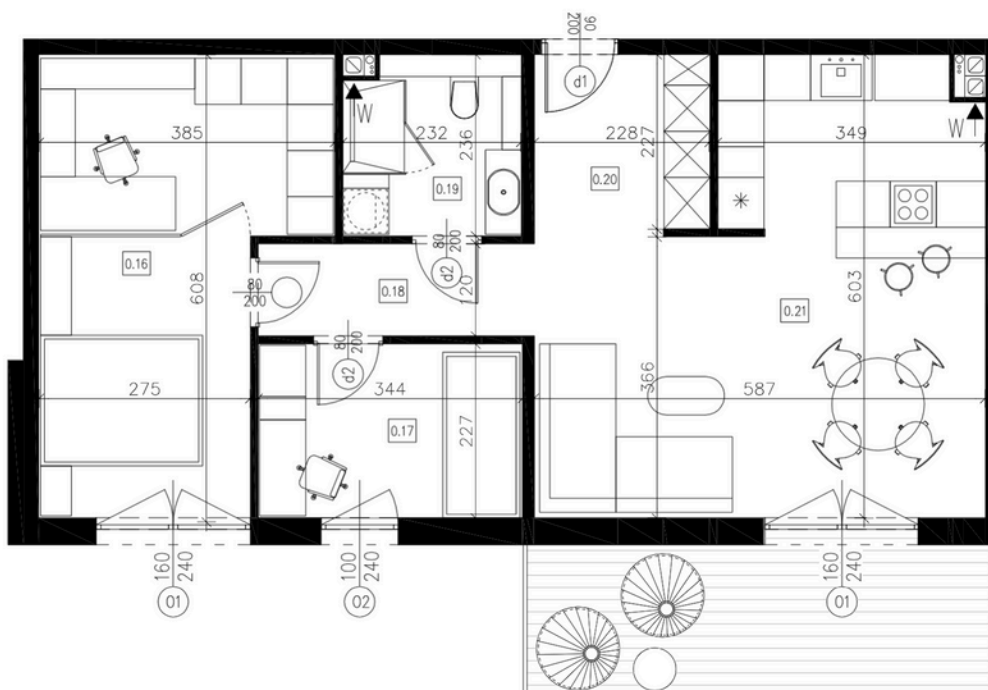

0.16	POKÓJ	19,13	POW. UŻYTKOWA 71,20 M ²
0.17	POKÓJ	7,79	
0.18	PRZEDPOKÓJ	4,30	
0.19	ŁAZIENKA	5,31	
0.20	PRZEDPOKÓJ	5,34	
0.21	SALON Z KUCHNIĄ	29,33	



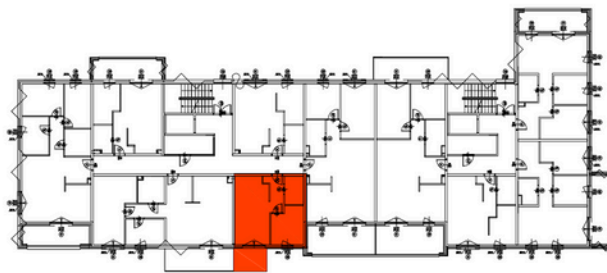

MIESZKANIE NR 12

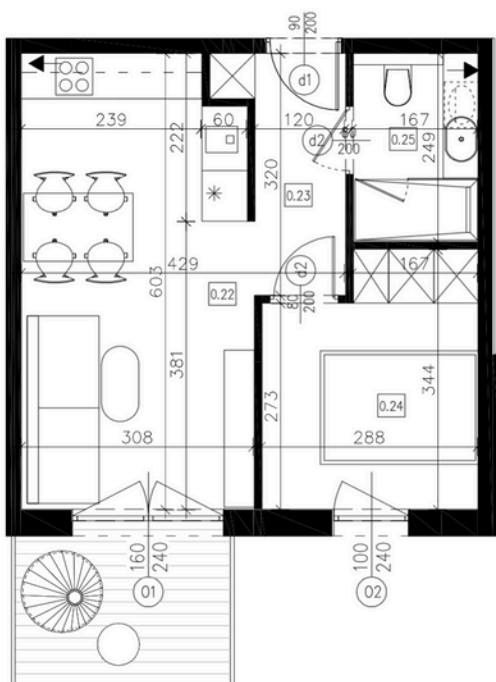

0.22	SALON Z KUCHNIĄ	17,91	POW. UŻYTKOWA 35,28 M2
0.23	PRZEDPOKÓJ	4,20	
0.24	POKÓJ	9,02	
0.25	ŁAZIENKA	4,15	



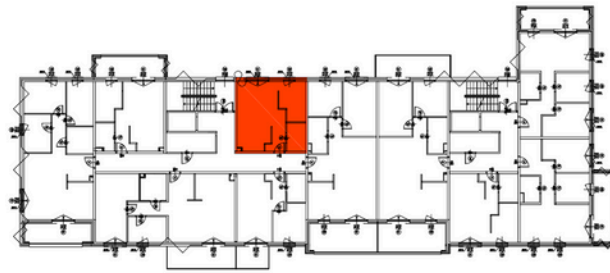

MIESZKANIE NR 13

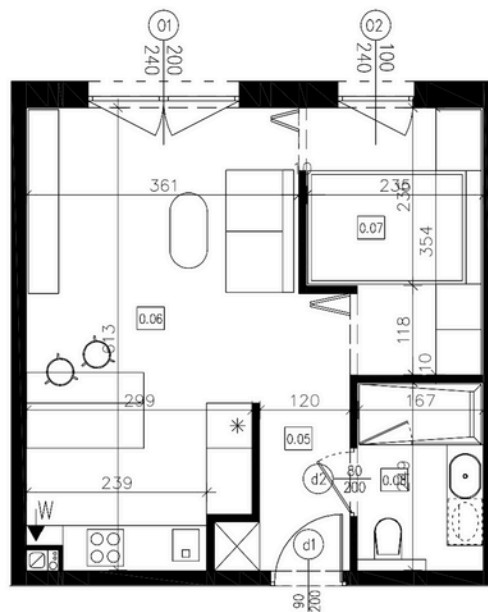

0.05	PRZEDPOKÓJ	3,05	POW. UŻYTKOWA 35,80 M ²
0.06	SALON Z KUCHNIĄ	21,11	
0.07	POKÓJ	7,49	
0.08	ŁAZIENKA	4,15	



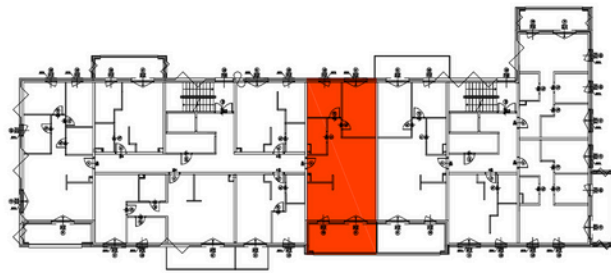

MIESZKANIE NR 14 NP

0.16	PRZEDPOKÓJ	10,20	POW. UŻYTKOWA 71,00 M ²
0.17	ŁAZIENKA	5,11	
0.18	POKÓJ	9,27	
0.19	POKÓJ	14,13	
0.20	SALON Z KUCHNIĄ	32,29	

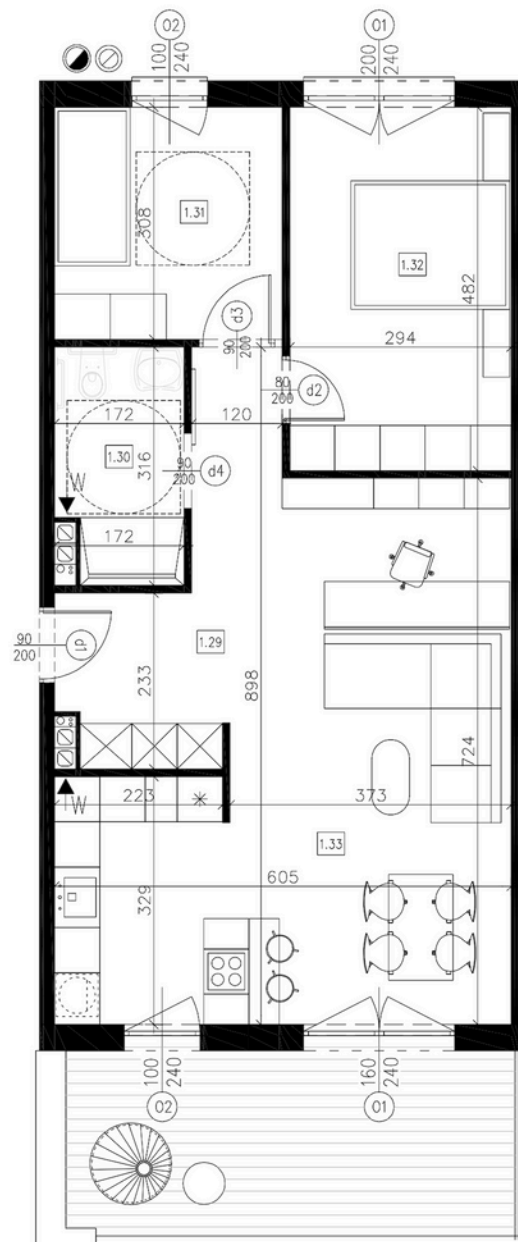

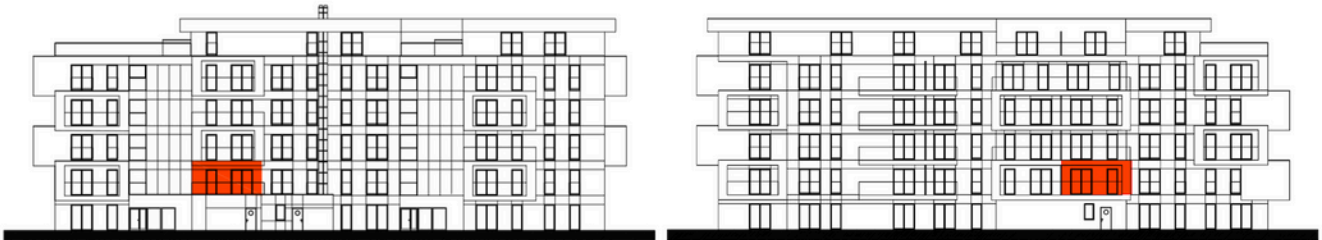
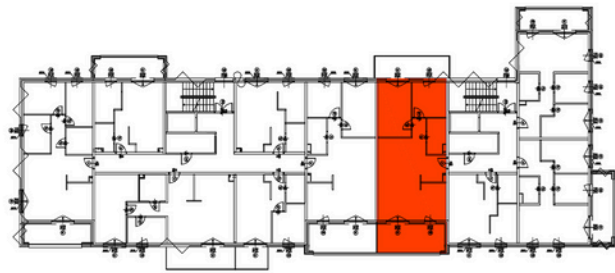

MIESZKANIE NR 15 NP

0.16	PRZEDPOKÓJ	10,20	POW. UŻYTKOWA 71,00 M ²
0.17	ŁAZIENKA	5,11	
0.18	POKÓJ	9,27	
0.19	POKÓJ	14,13	
0.20	SALÓN Z KUCHNIĄ	32,29	

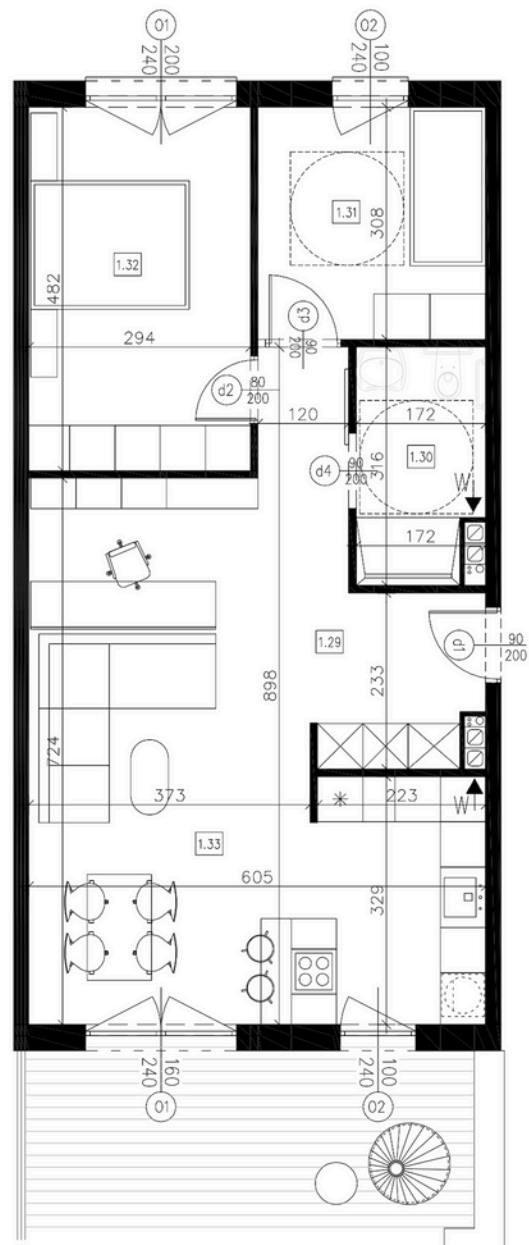

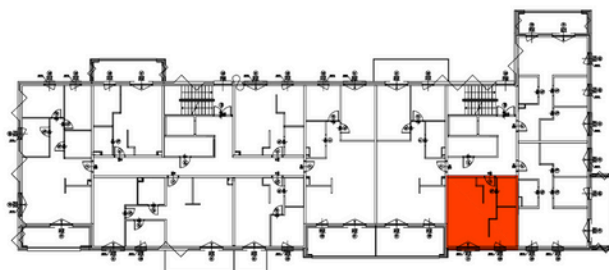

MIESZKANIE NR 16

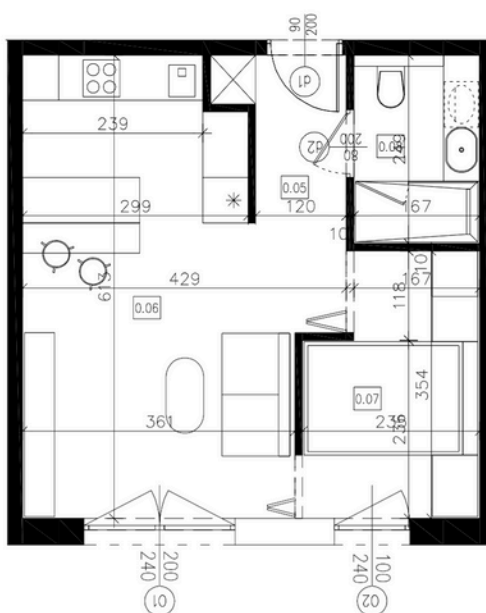

0.05	PRZEDPOKÓJ	3,05	POW. UŻYTKOWA 35,93 M ²
0.06	SALON Z KUCHNIĄ	21,24	
0.07	POKÓJ	7,49	
0.08	ŁAZIENKA	4,15	



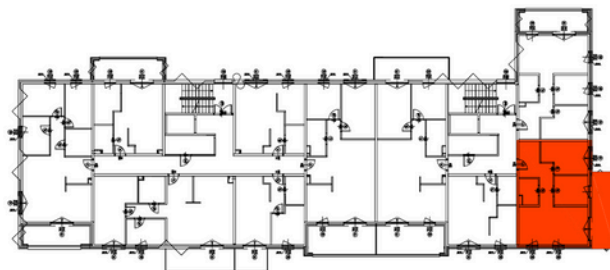

MIESZKANIE NR 17

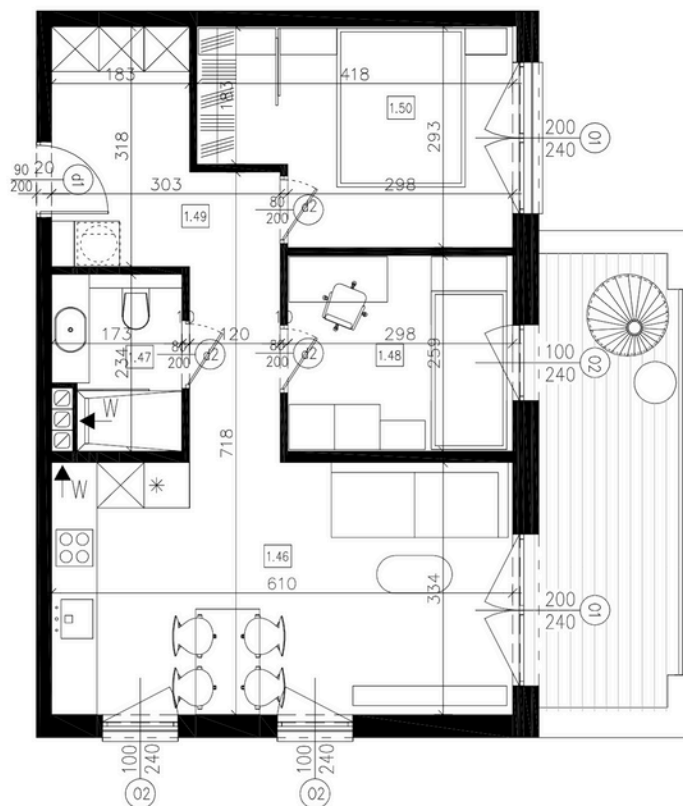

0.43	SALON Z KUCHNIĄ	20,37	POW. UŻYTKOWA 53,37 M2
0.44	ŁAZIENKA	3,73	
0.45	POKÓJ	7,83	
0.46	PRZEDPOKÓJ	10,40	
0.47	POKÓJ	11,04	



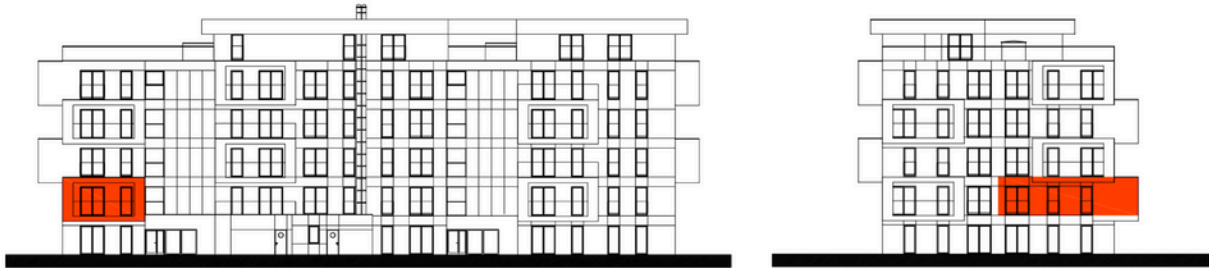
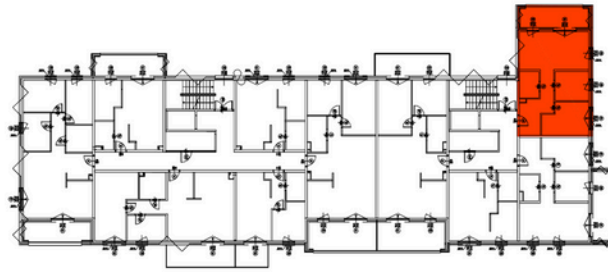

MIESZKANIE NR 18

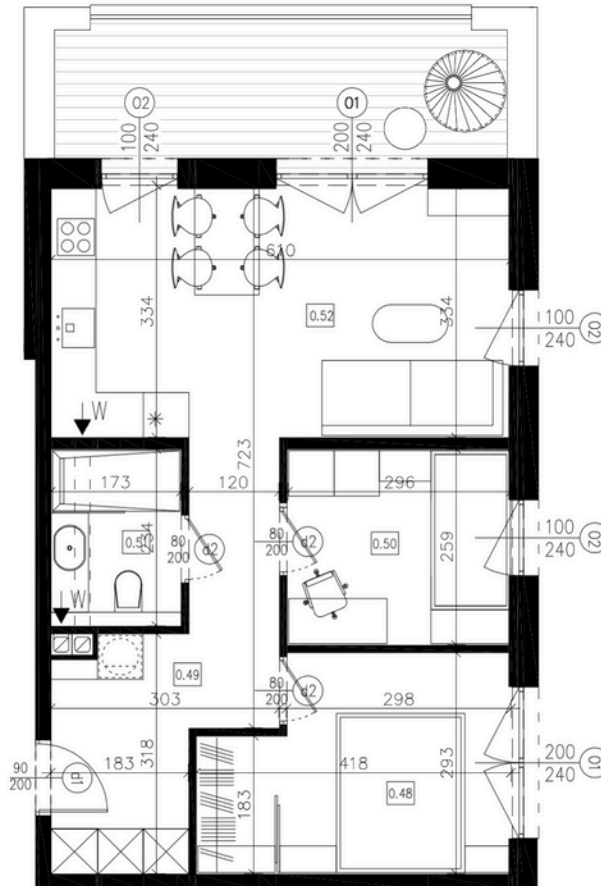

0.48	POKÓJ	11,04	POW. UŻYTKOWA 53,68 M ²
0.49	PRZEDPOKÓJ	10,40	
0.50	POKÓJ	7,83	
0.51	ŁAZIENKA	4,04	
0.52	SALON Z KUCHNIĄ	20,37	



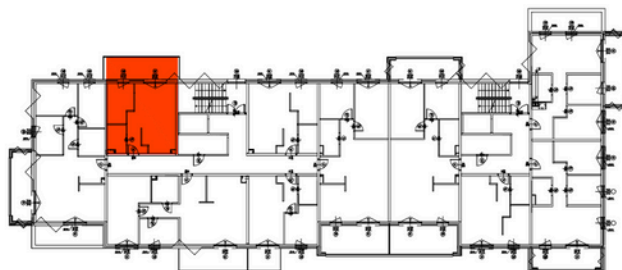

MIESZKANIE NR 19

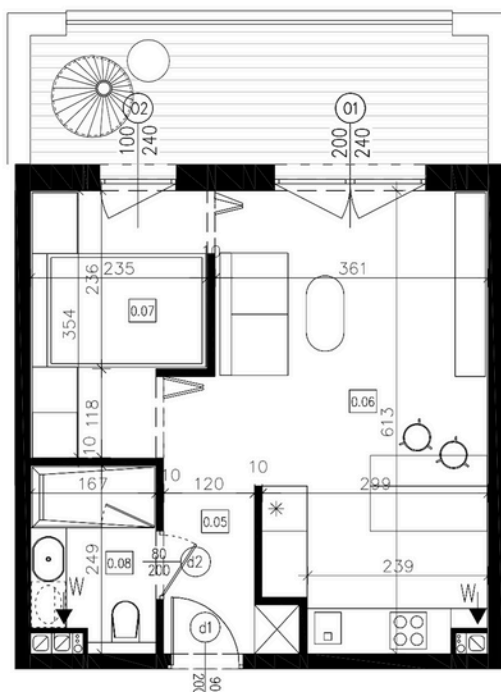

0.05	PRZEDPOKÓJ	3,05	POW. UŻYTKOWA 35,50 M2
0.06	SALON Z KUCHNIĄ	21,07	
0.07	POKÓJ	7,49	
0.08	ŁAZIENKA	3,89	



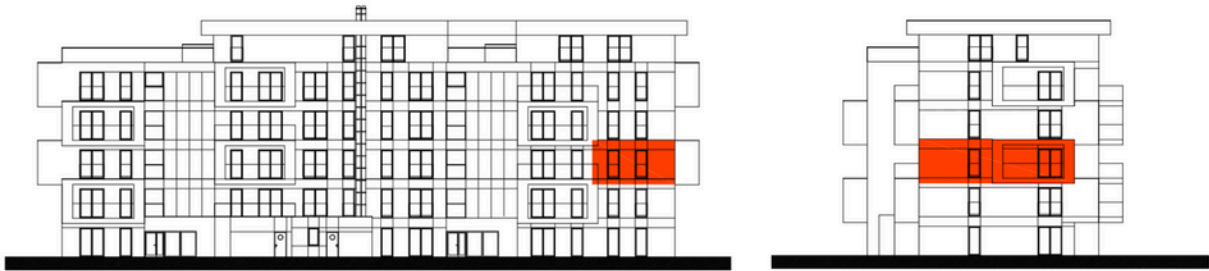
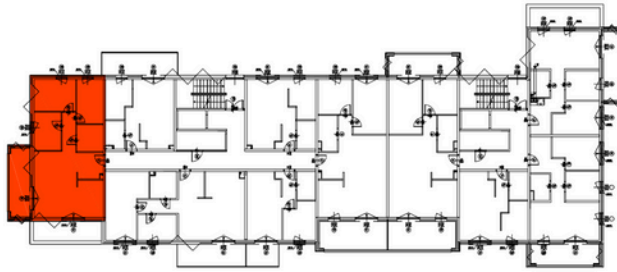

MIESZKANIE NR 20

0.09	PRZEDPOKÓJ	5,24	POW. UŻYTKOWA 71,09 M ²
0.10	ŁAZIENKA	5,46	
0.11	PRZEDPOKÓJ	4,25	
0.12	POKÓJ	8,98	
0.13	POKÓJ	10,06	
0.14	POKÓJ	7,92	
0.15	SALON Z KUCHNIĄ	29,18	

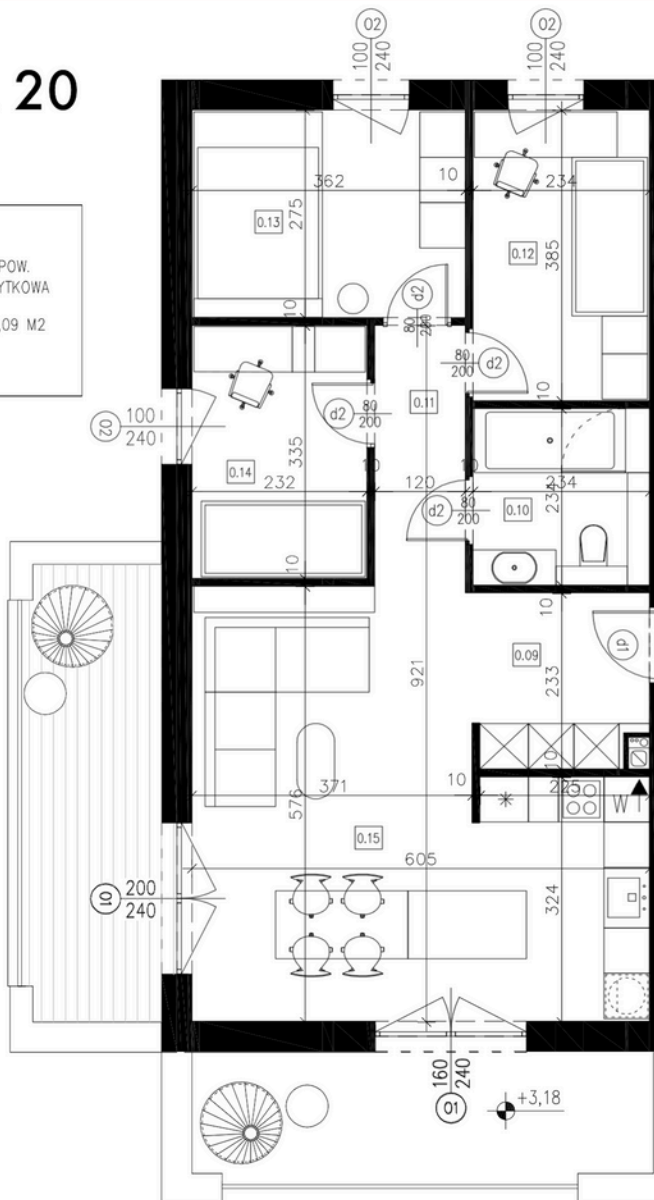

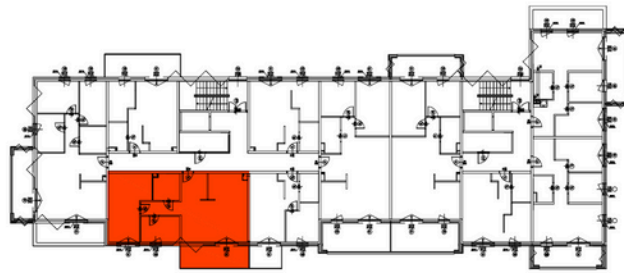

MIESZKANIE NR 21

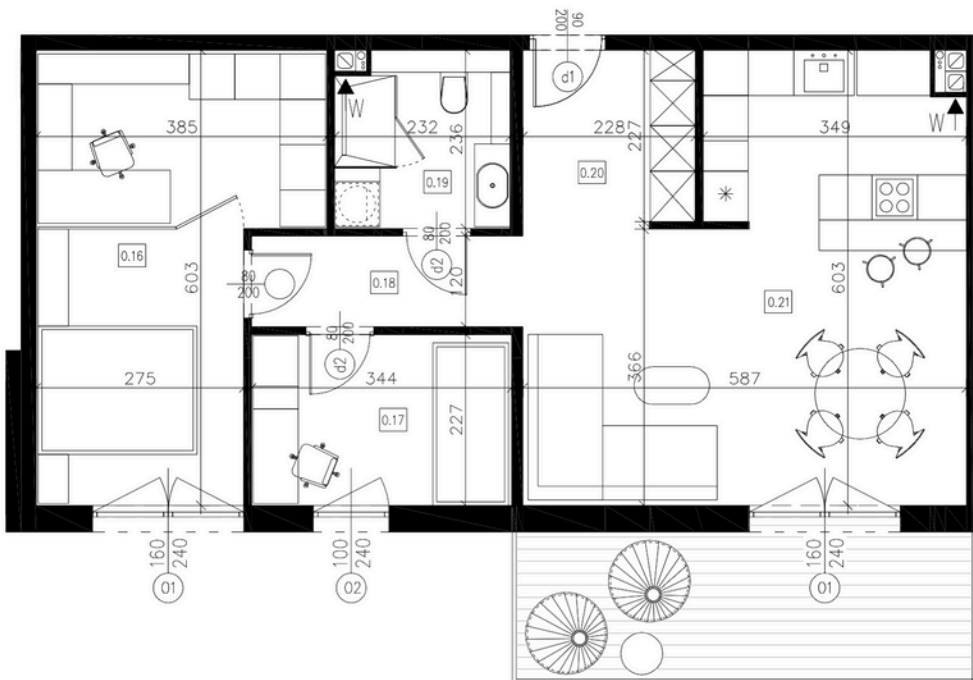

0.16	POKÓJ	19,13	POW. UŻYTKOWA 71,20 M2
0.17	POKÓJ	7,79	
0.18	PRZEDPOKÓJ	4,30	
0.19	ŁAZIENKA	5,31	
0.20	PRZEDPOKÓJ	5,34	
0.21	SALON Z KUCHNIĄ	29,33	



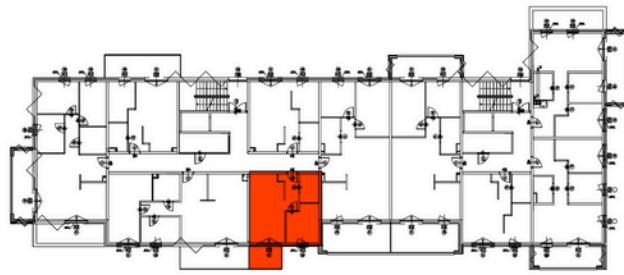

MIESZKANIE NR 22

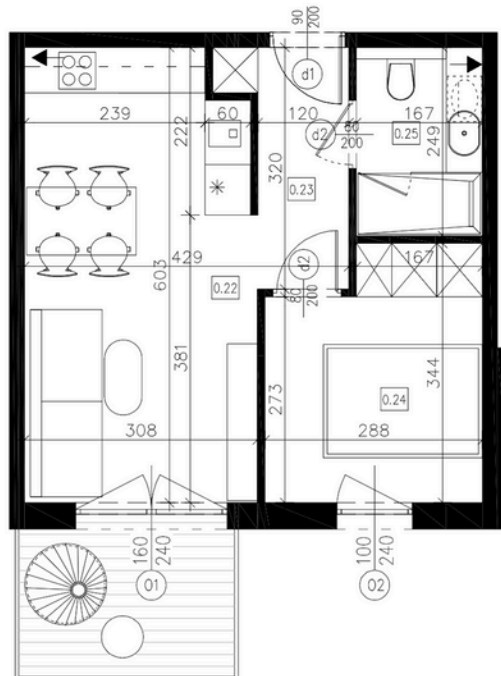

0.22	SALON Z KUCHNIĄ	17,91	POW. UŻYTKOWA 35,28 M2
0.23	PRZEDPOKÓJ	4,20	
0.24	POKÓJ	9,02	
0.25	ŁAZIENKA	4,15	



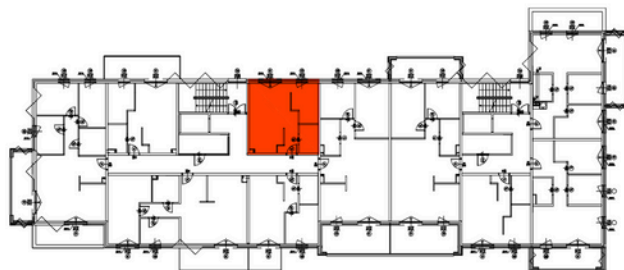

MIESZKANIE NR 23

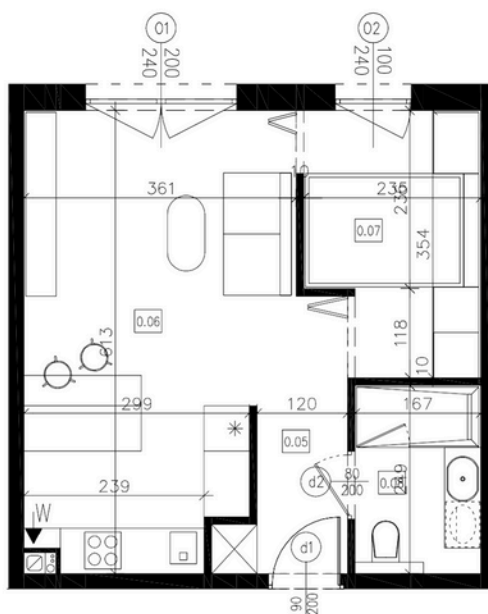

0.05	PRZEDPOKÓJ	3,05	POW. UŻYTKOWA 35,80 M ²
0.06	SALON Z KUCHNIĄ	21,11	
0.07	POKÓJ	7,49	
0.08	ŁAZIENKA	4,15	



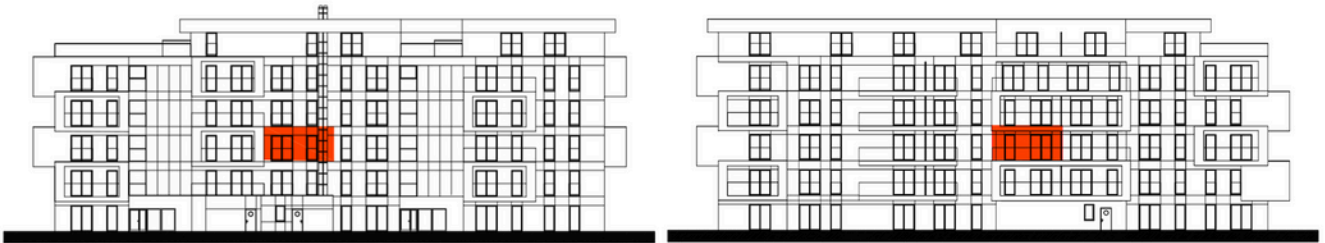
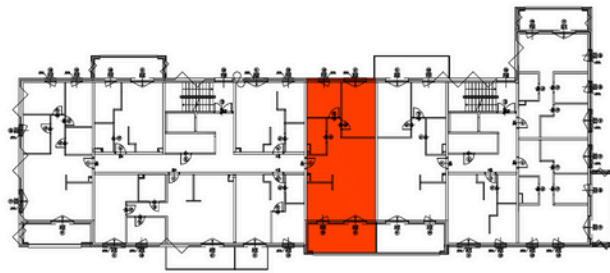

MIESZKANIE NR 24 NP

0.16	PRZEDPOKÓJ	10,20	POW. UŻYTKOWA 71,00 M ²
0.17	ŁAZIENKA	5,11	
0.18	POKÓJ	9,27	
0.19	POKÓJ	14,13	
0.20	SALON Z KUCHNIĄ	32,29	

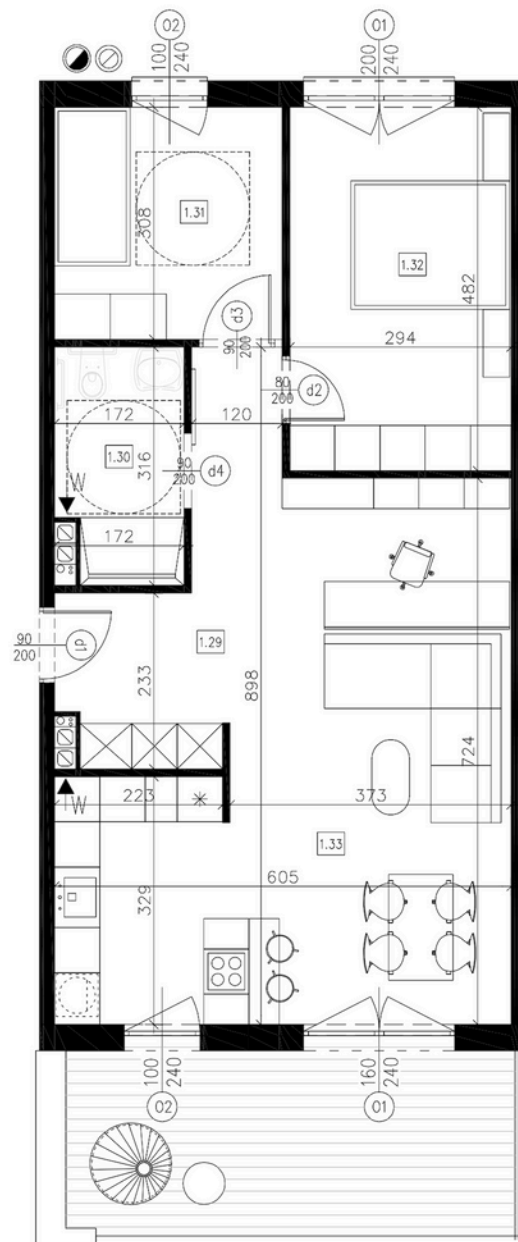

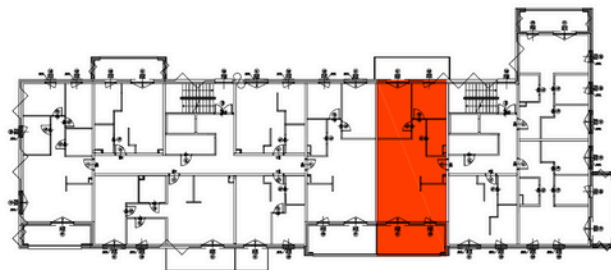

MIESZKANIE NR 25

0.16	PRZEDPOKÓJ	10,20	POW. UŻYTKOWA 71,00 M ²
0.17	ŁAZIENKA	5,11	
0.18	POKÓJ	9,27	
0.19	POKÓJ	14,13	
0.20	SALON Z KUCHNIĄ	32,29	

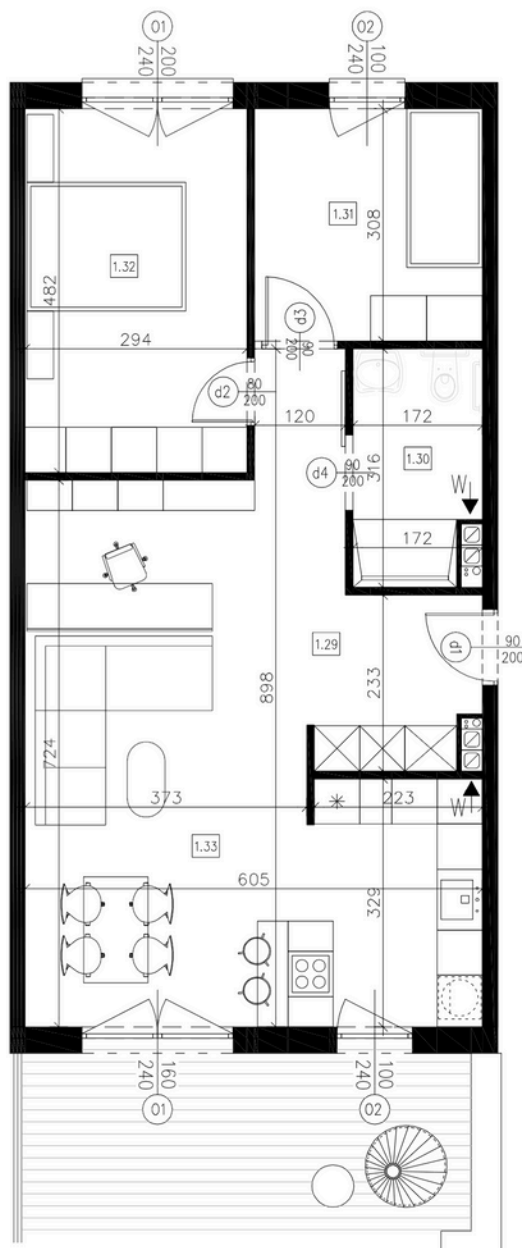

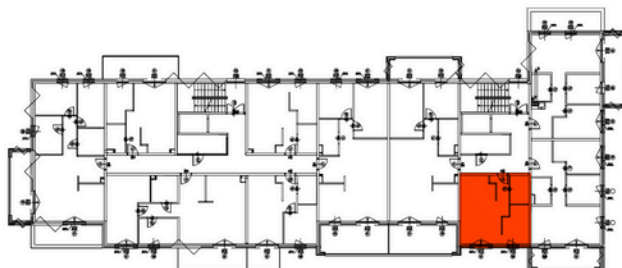

MIESZKANIE NR 26

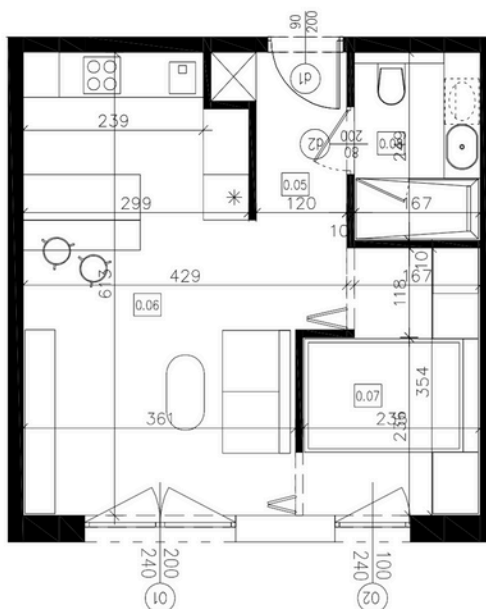

0.05	PRZEDPOKÓJ	3,05	POW. UŻYTKOWA 35,93 M2
0.06	SALON Z KUCHNIĄ	21,24	
0.07	POKÓJ	7,49	
0.08	ŁAZIENKA	4,15	



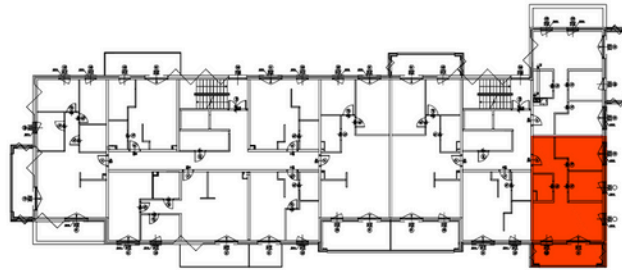

MIESZKANIE NR 27

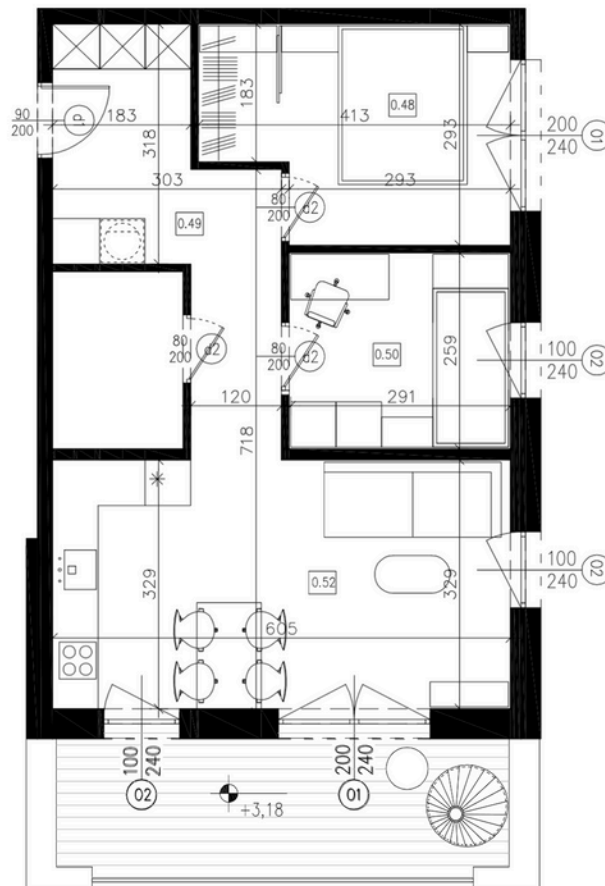

0.43	SALON Z KUCHNIĄ	20,37	POW. UŻYTKOWA 53,37 M ²
0.44	ŁAZIENKA	3,73	
0.45	POKÓJ	7,83	
0.46	PRZEDPOKÓJ	10,40	
0.47	POKÓJ	11,04	



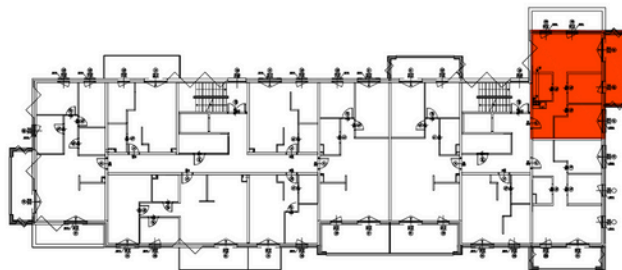

MIESZKANIE NR 28

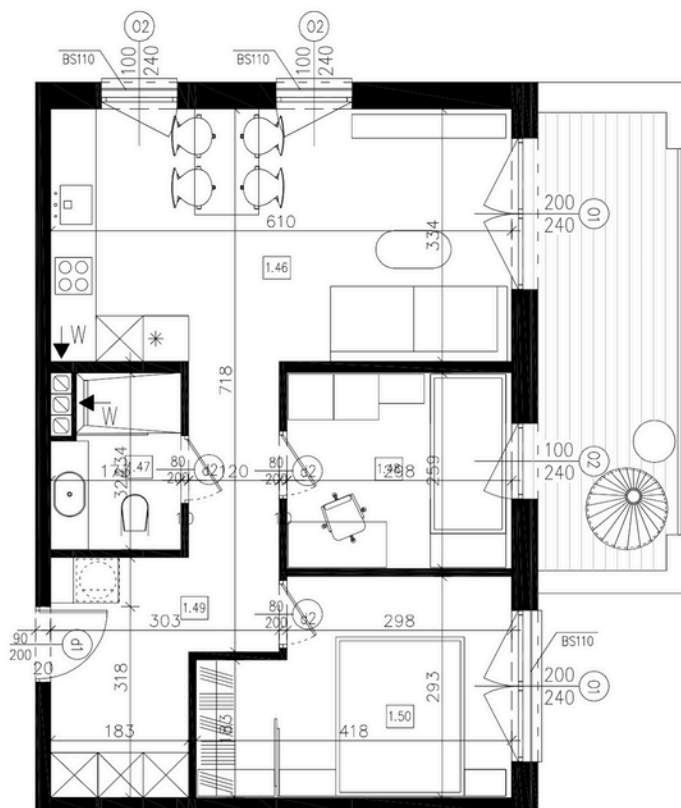

0.48	POKÓJ	11,04	POW. UŻYTKOWA 53,68 M2
0.49	PRZEDPOKÓJ	10,40	
0.50	POKÓJ	7,83	
0.51	ŁAZIENKA	4,04	
0.52	SALON Z KUCHNIĄ	20,37	



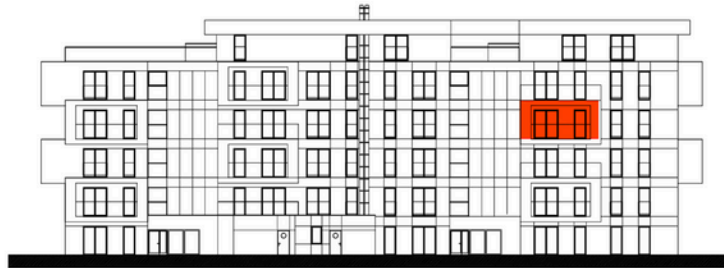
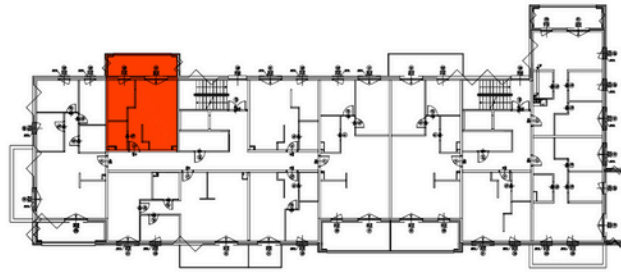

MIESZKANIE NR 29

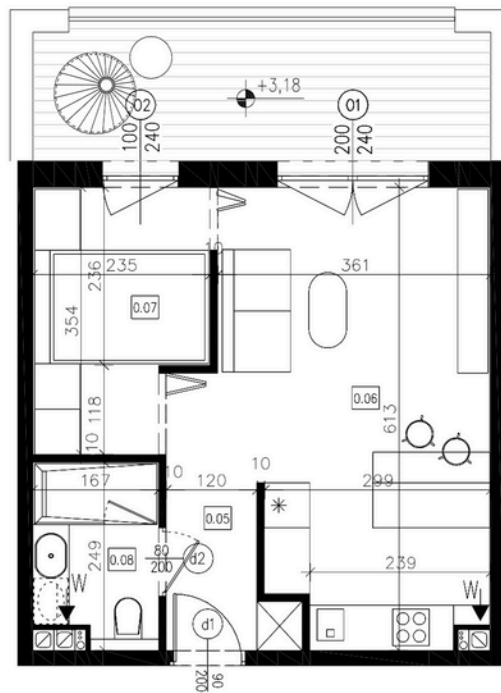

0.05	PRZEDPOKÓJ	3,05	POW. UŻYTKOWA 35,50 M2
0.06	SALON Z KUCHNIĄ	21,07	
0.07	POKÓJ	7,49	
0.08	ŁAZIENKA	3,89	



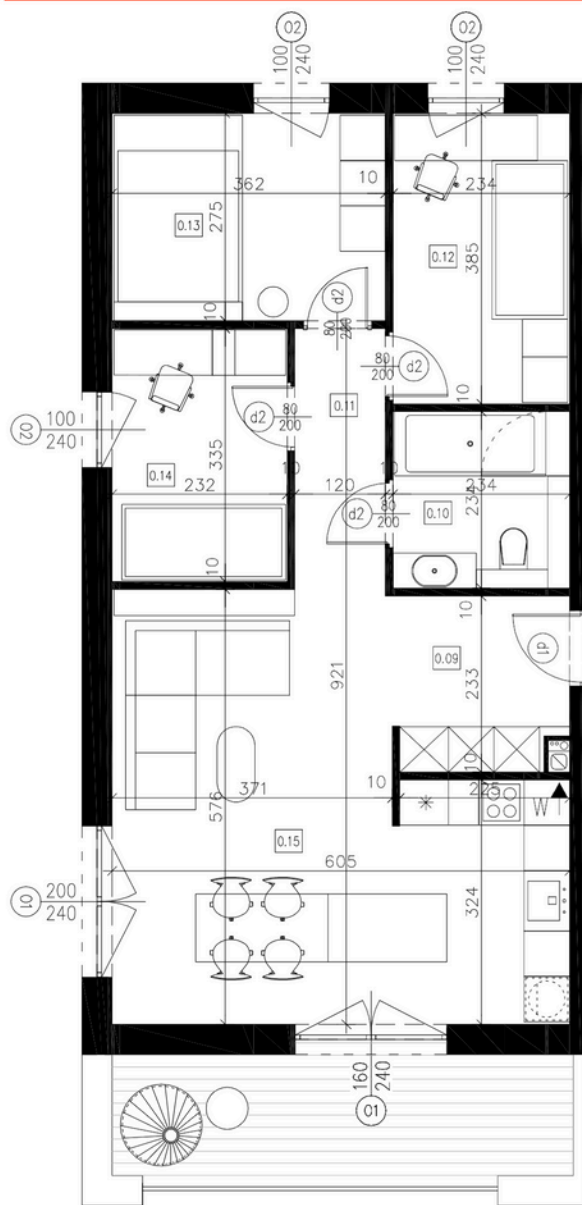
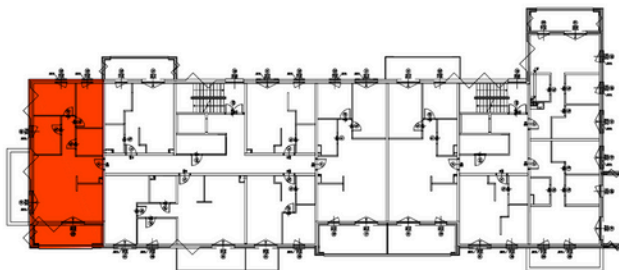

MIESZKANIE NR 30

0.09	PRZEDPOKÓJ	5,24	POW. UŻYTKOWA 71,09 M2
0.10	ŁAZIENKA	5,46	
0.11	PRZEDPOKÓJ	4,25	
0.12	POKÓJ	8,98	
0.13	POKÓJ	10,06	
0.14	POKÓJ	7,92	
0.15	SALON Z KUCHNIĄ	29,18	



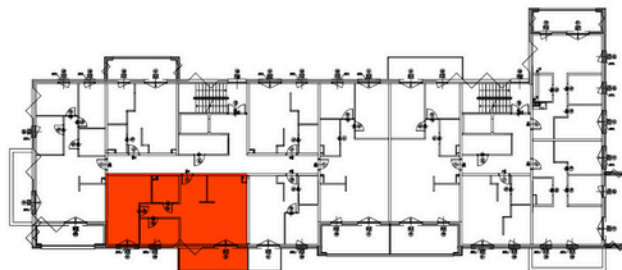

MIESZKANIE NR 31

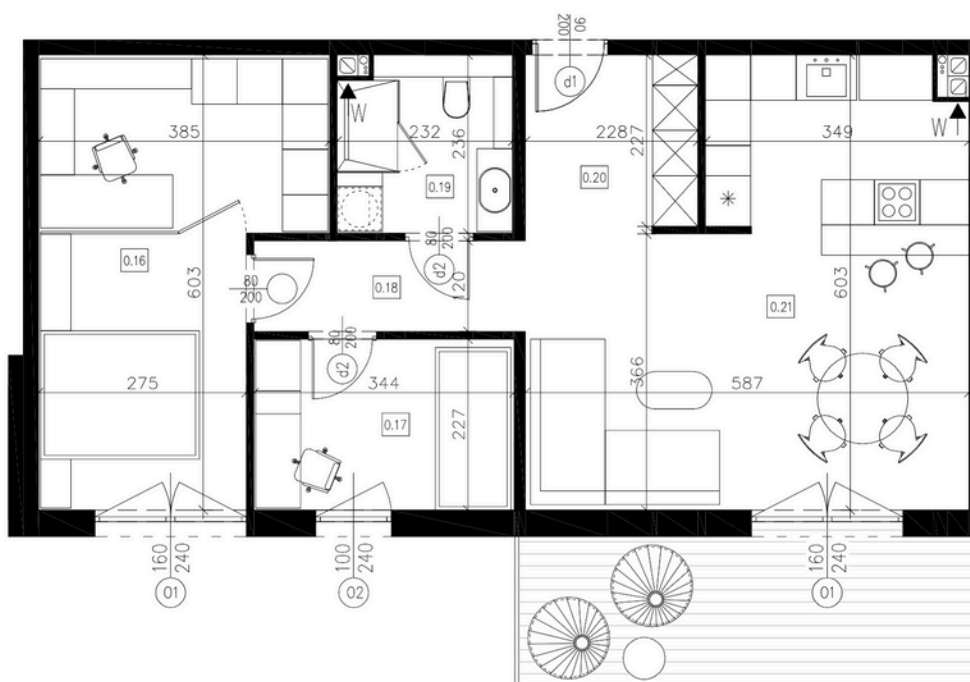

0.16	POKÓJ	19,13	POW. UŻYTKOWA 71,20 M ²
0.17	POKÓJ	7,79	
0.18	PRZEDPOKÓJ	4,30	
0.19	ŁAZIENKA	5,31	
0.20	PRZEDPOKÓJ	5,34	
0.21	SALON Z KUCHNIĄ	29,33	



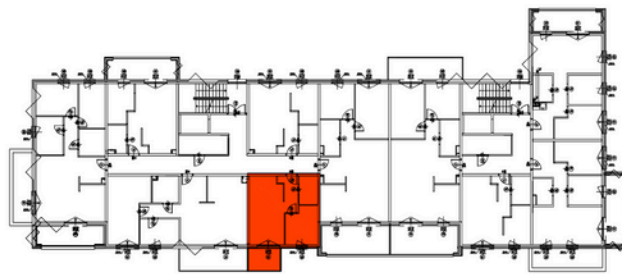

MIESZKANIE NR 32

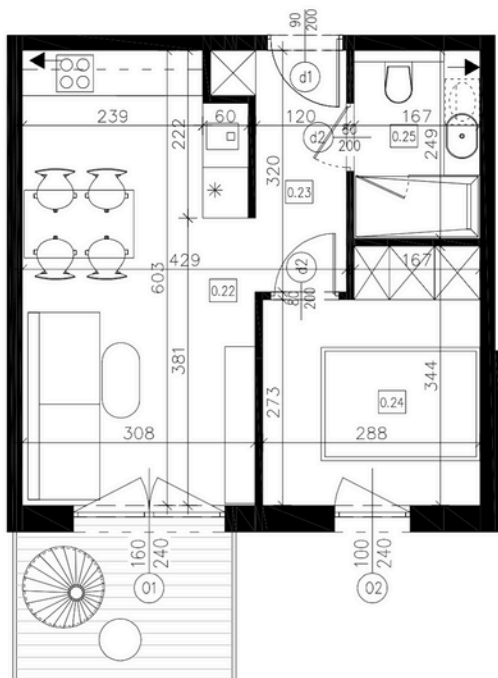

0.22	SALON Z KUCHNIĄ	17,91	POW. UŻYTKOWA 35,28 M2
0.23	PRZEDPOKÓJ	4,20	
0.24	POKÓJ	9,02	
0.25	ŁAZIENKA	4,15	



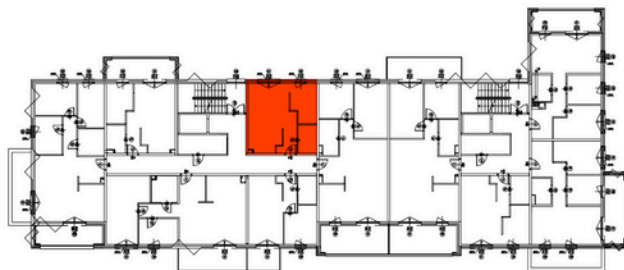

MIESZKANIE NR 33

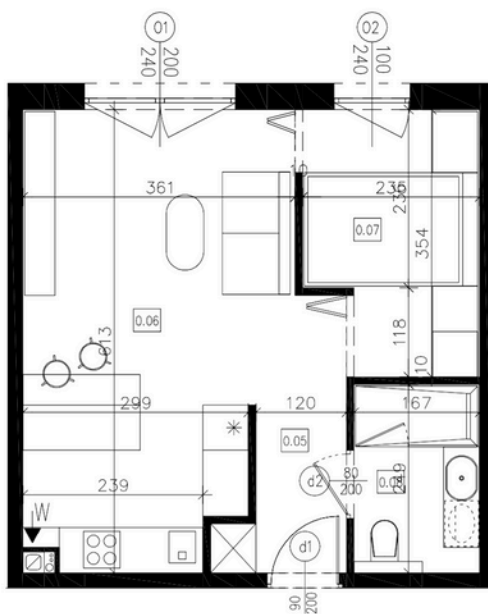

0.05	PRZEDPOKÓJ	3,05	POW. UŻYTKOWA 35,80 M ²
0.06	SALON Z KUCHNIĄ	21,11	
0.07	POKÓJ	7,49	
0.08	ŁAZIENKA	4,15	



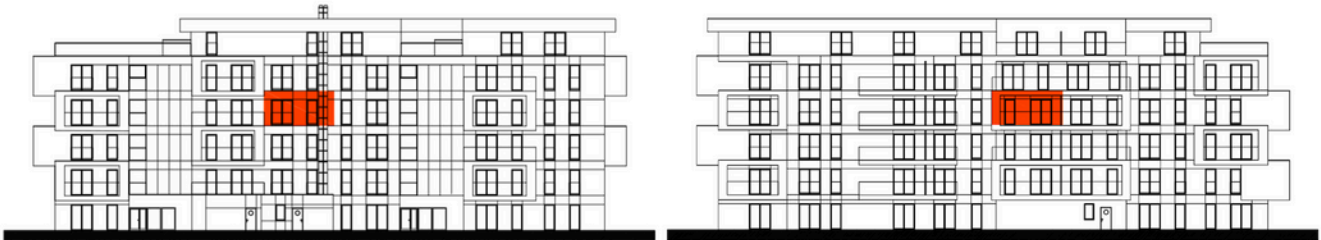
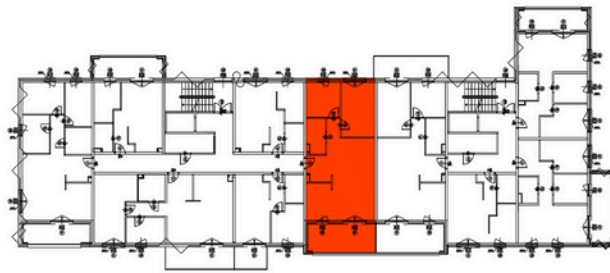

MIESZKANIE NR 34 NP

0.16	PRZEDPOKÓJ	10,20	POW. UŻYTKOWA 71,00 M ²
0.17	ŁAZIENKA	5,11	
0.18	POKÓJ	9,27	
0.19	POKÓJ	14,13	
0.20	SALON Z KUCHNIĄ	32,29	

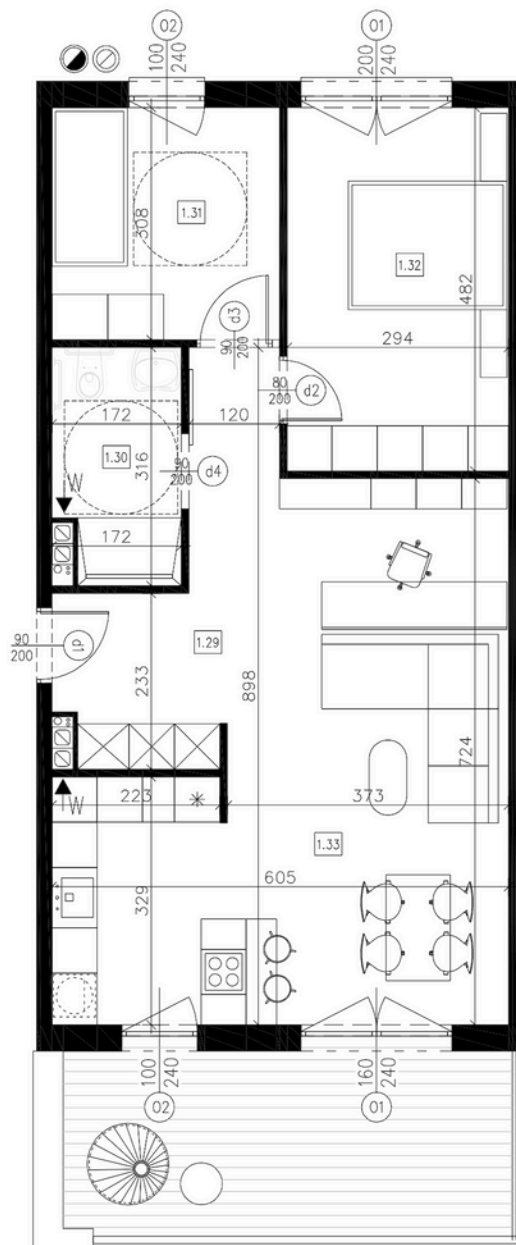

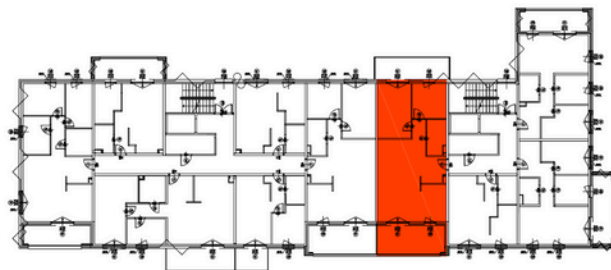

MIESZKANIE NR 35

0.16	PRZEDPOKÓJ	10,20	POW. UŻYTKOWA 71,00 M ²
0.17	ŁAZIENKA	5,11	
0.18	POKÓJ	9,27	
0.19	POKÓJ	14,13	
0.20	SALON Z KUCHNIĄ	32,29	

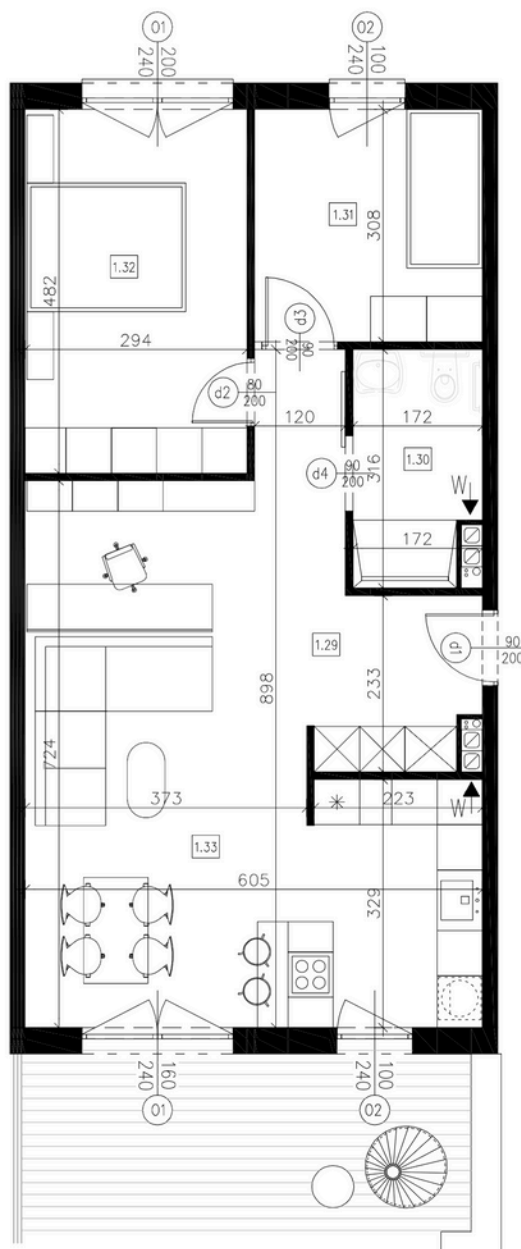

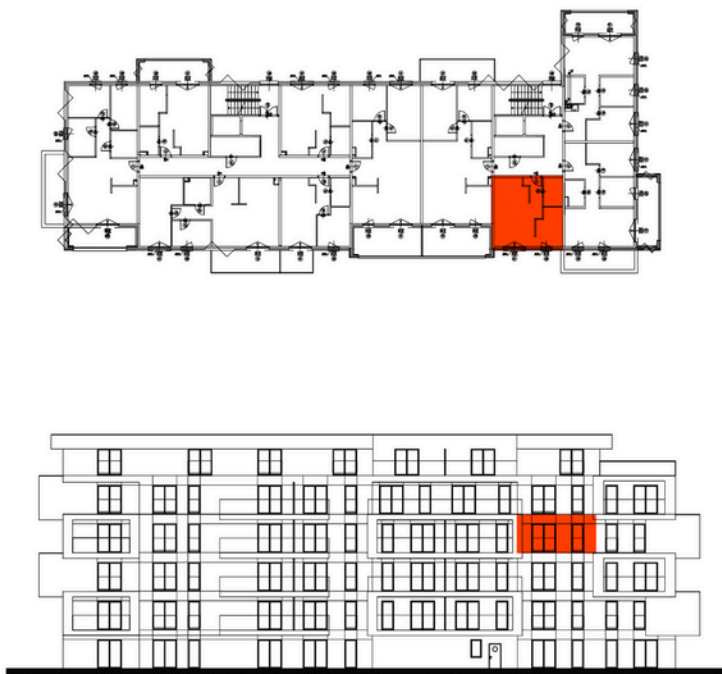

MIESZKANIE NR 36

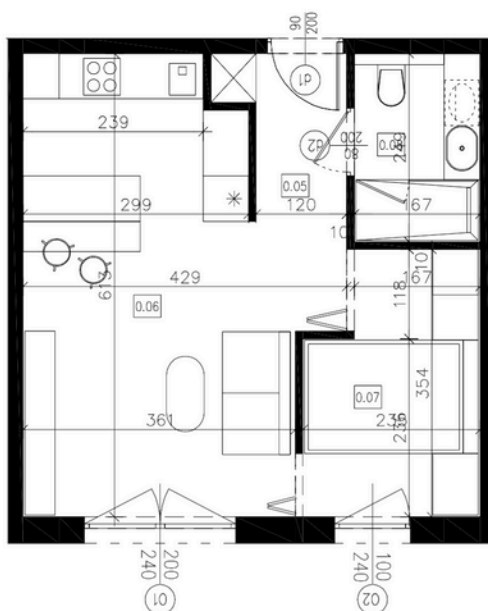

0.05	PRZEDPOKÓJ	3,05	POW. UŻYTKOWA 35,93 M ²
0.06	SALON Z KUCHNIĄ	21,24	
0.07	POKÓJ	7,49	
0.08	ŁAZIENKA	4,15	



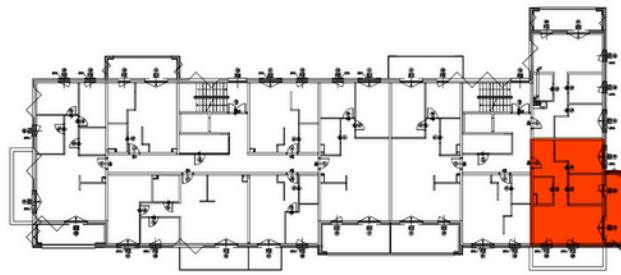

MIESZKANIE NR 37

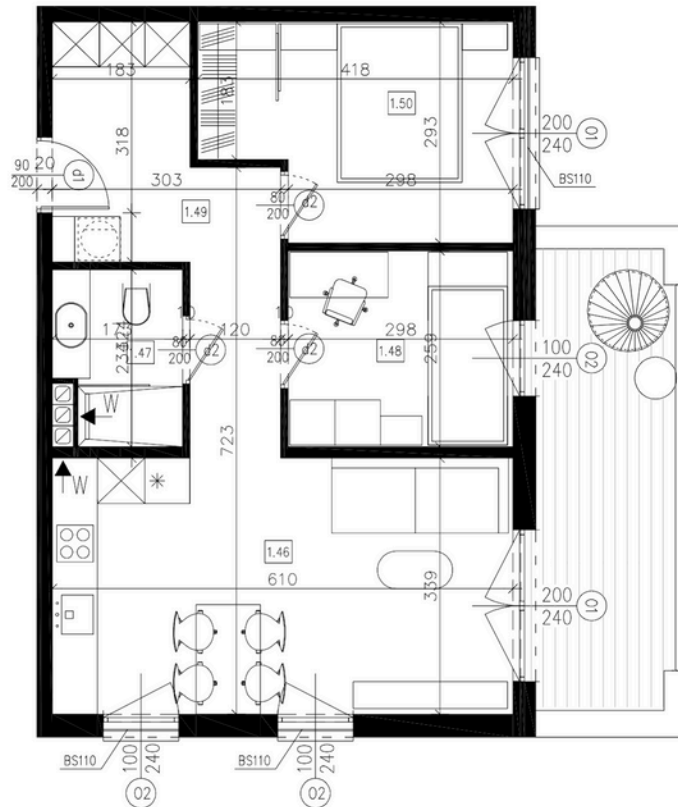

0.43	SALON Z KUCHNIĄ	20,37	POW. UŻYTKOWA 53,37 M2
0.44	ŁAZIENKA	3,73	
0.45	POKÓJ	7,83	
0.46	PRZEDPOKÓJ	10,40	
0.47	POKÓJ	11,04	



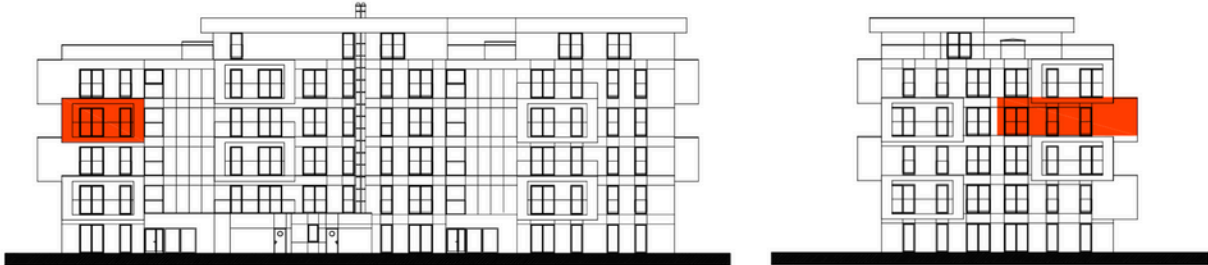
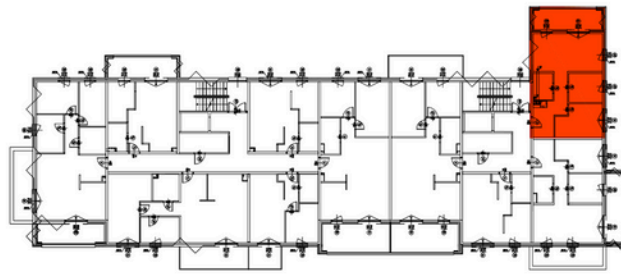

MIESZKANIE NR 38

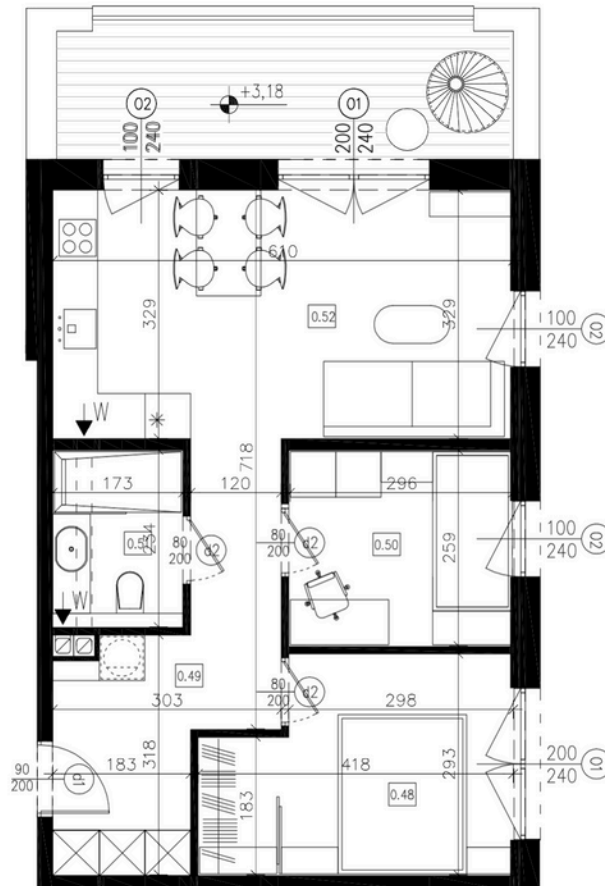

0.48	POKÓJ	11,04	POW. UŻYTKOWA 53,68 M2
0.49	PRZEDPOKÓJ	10,40	
0.50	POKÓJ	7,83	
0.51	ŁAZIENKA	4,04	
0.52	SALON Z KUCHNIĄ	20,37	



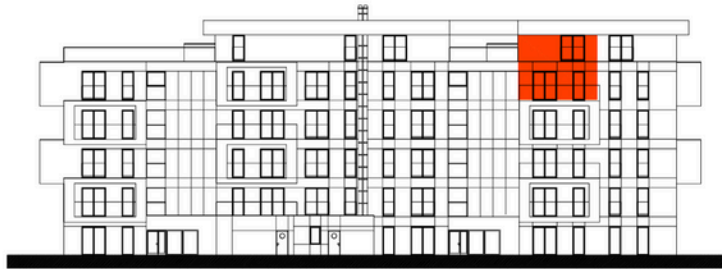
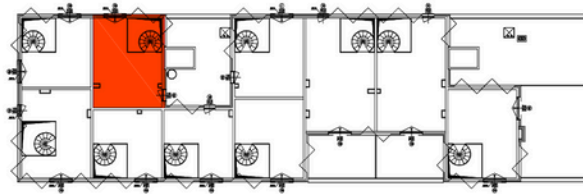
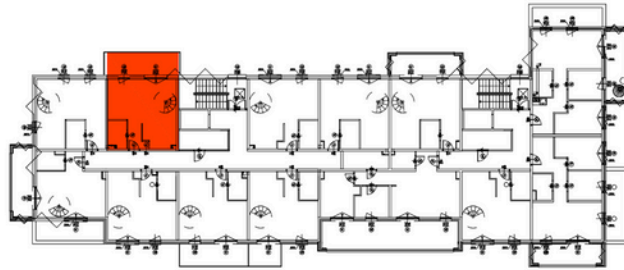

MIESZKANIE NR 39

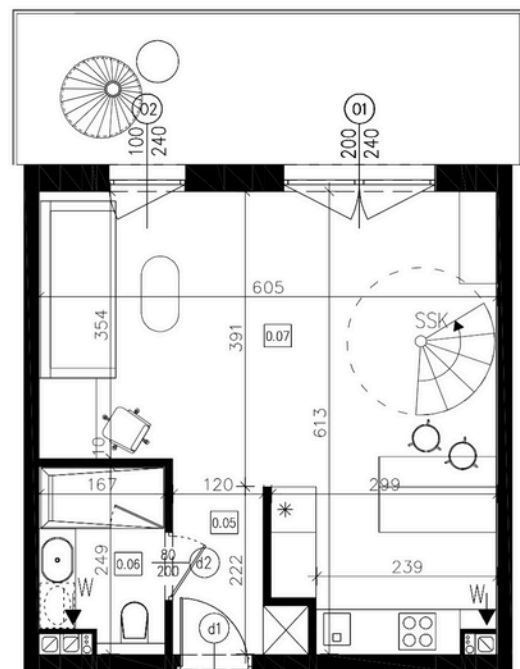
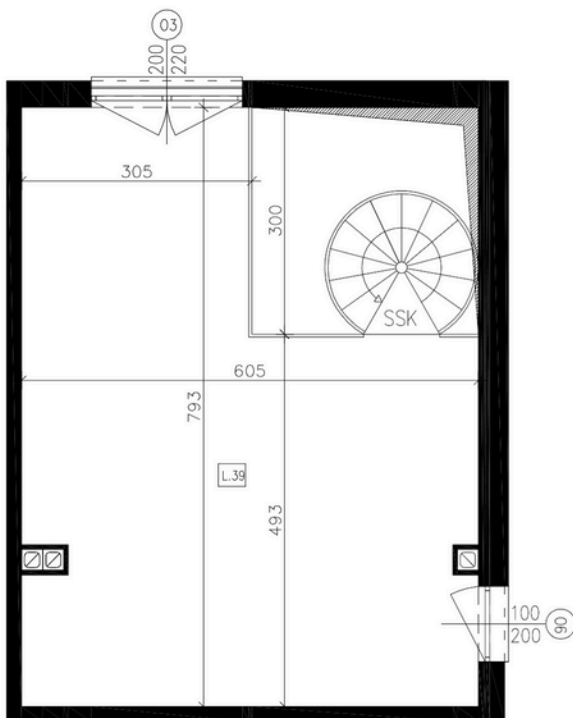

0.05	PRZEDPOKÓJ	3,05	POW. UŻYTKOWA 74,49 M2
0.06	ŁAZIENKA	3,89	
0.07	SALON Z KUCHNIĄ	28,99	
L_39	ANTRESOLA	38,56	



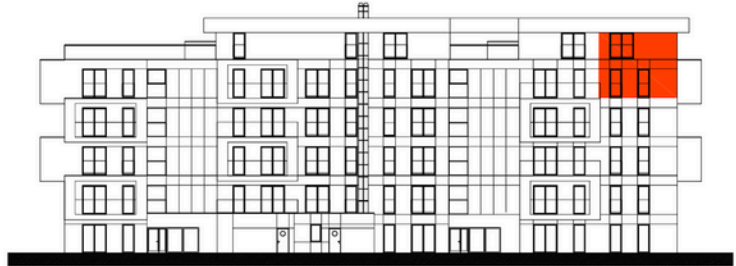
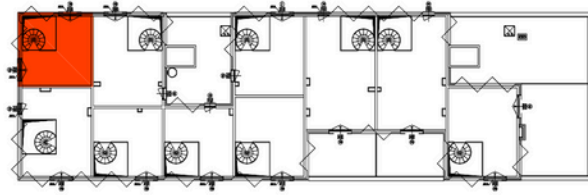
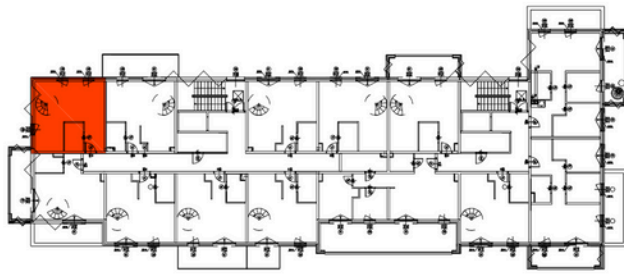

MIESZKANIE NR 40

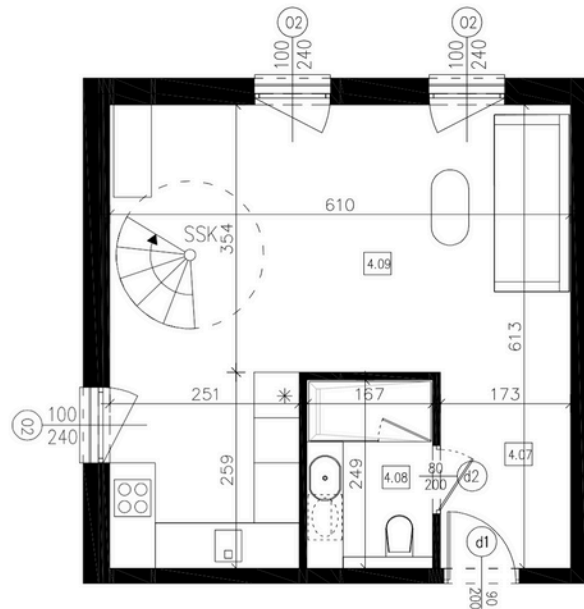
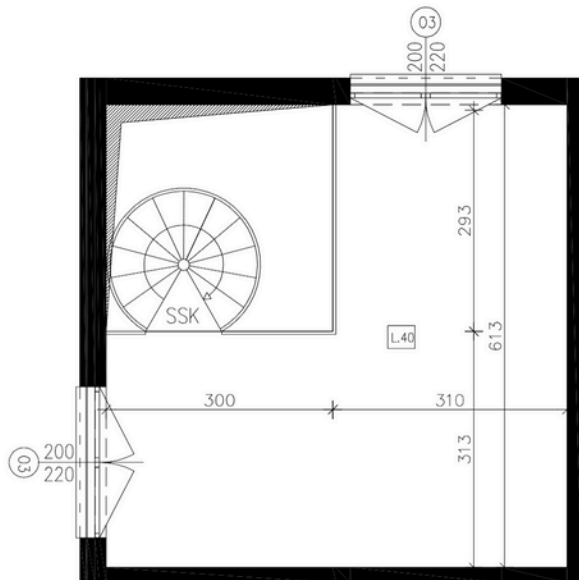

0.07	PRZEDPOKÓJ	4,47	POW. UŻYTKOWA
0.08	SALON Z KUCHNIĄ	4,15	
0.09	ŁAZIENKA	27,91	64,89 M2
L_40	ANTRESOLA	28,36	



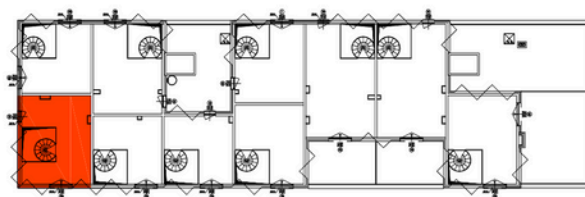
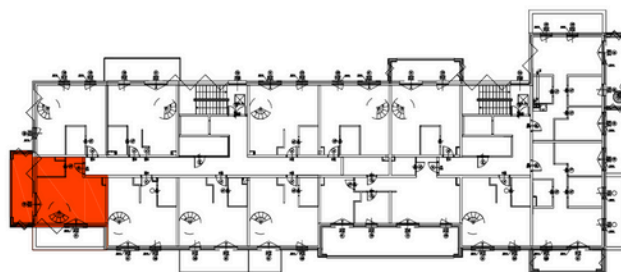

MIESZKANIE NR 41

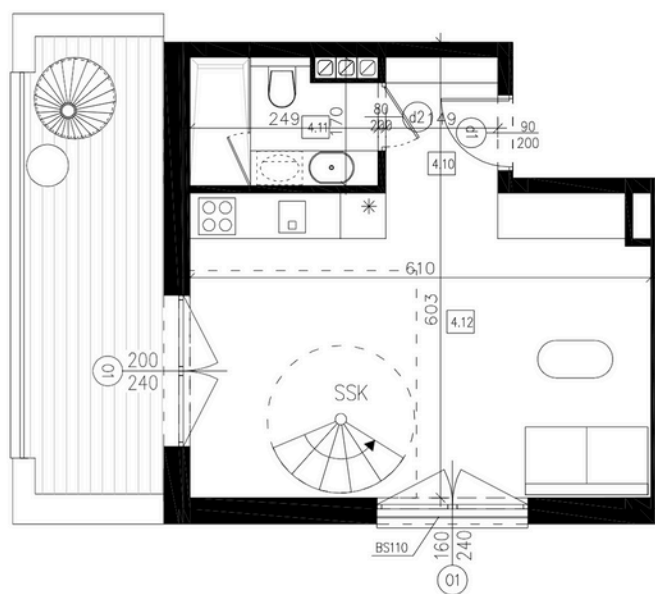
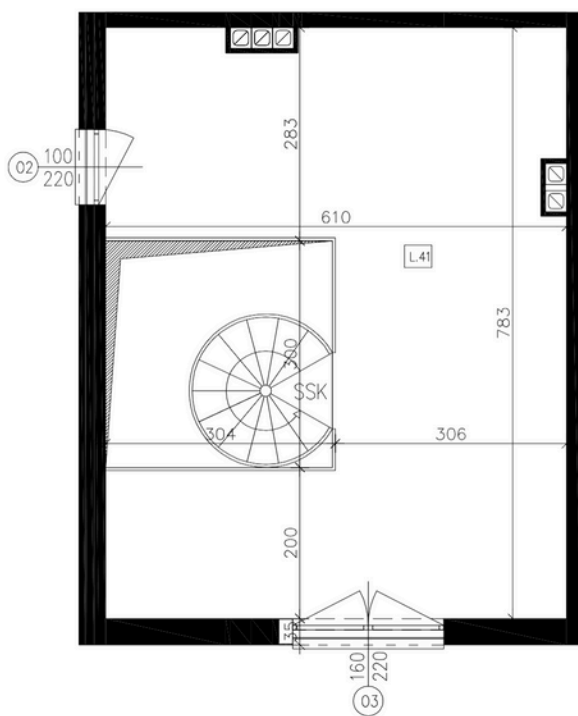

4.10	PRZEDPOKÓJ	2,67	POW. UŻYTKOWA 69,52 M2
4.11	ŁAZIENKA	3,93	
4.12	SALON Z KUCHNIĄ	24,32	
L_41	ANTRESOLA	38,60	



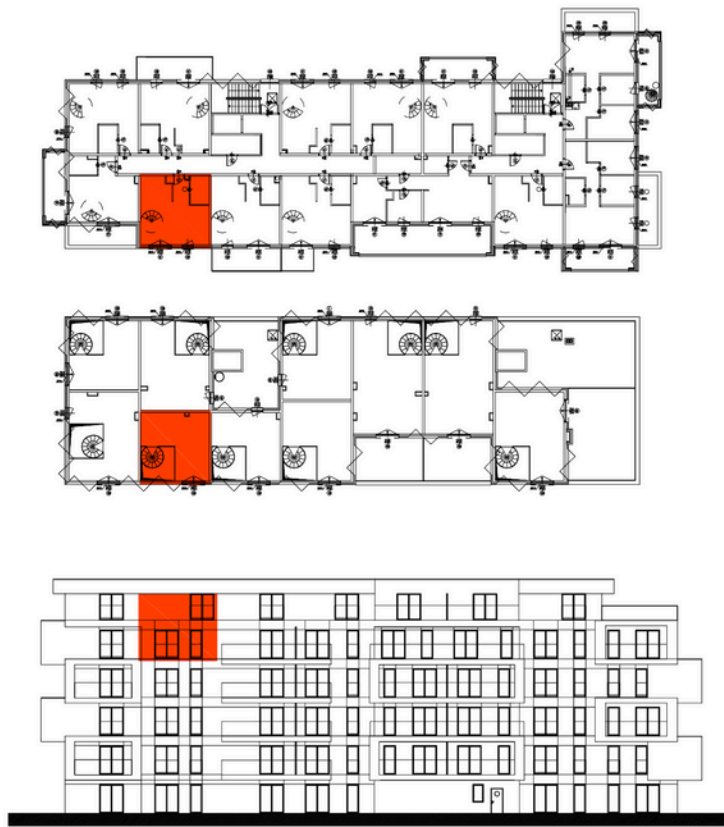

MIESZKANIE NR 42

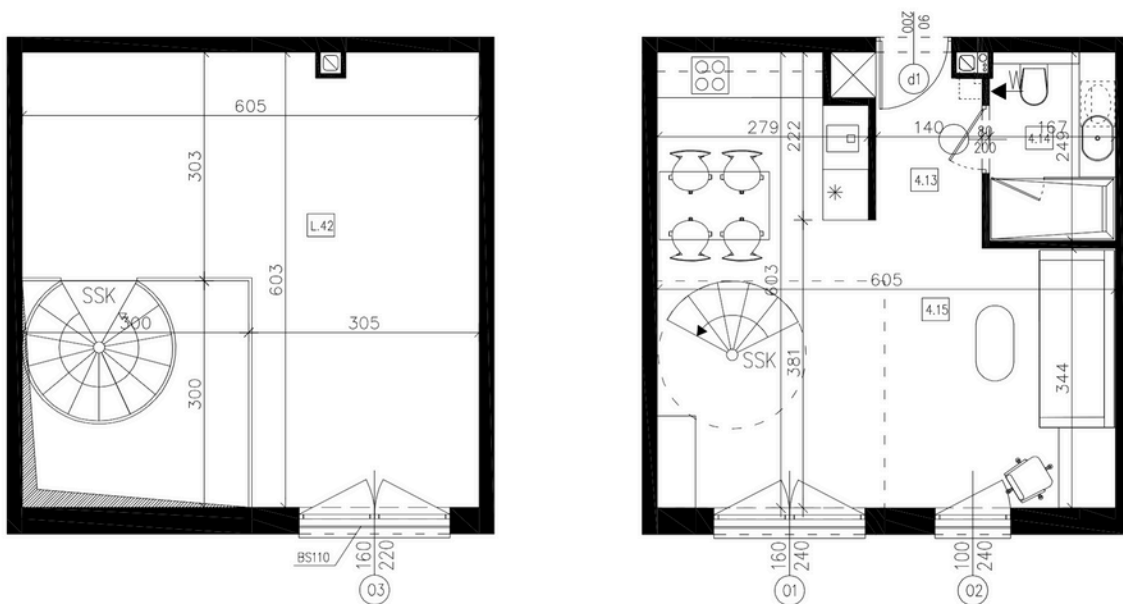

4.13	PRZEDPOKÓJ	3,33	POW. UŻYTKOWA 62,90 M2
4.14	ŁAZIENKA	4,13	
4.15	SALON Z KUCHNIĄ	28,13	
L_42	ANTRESOLA	27,31	



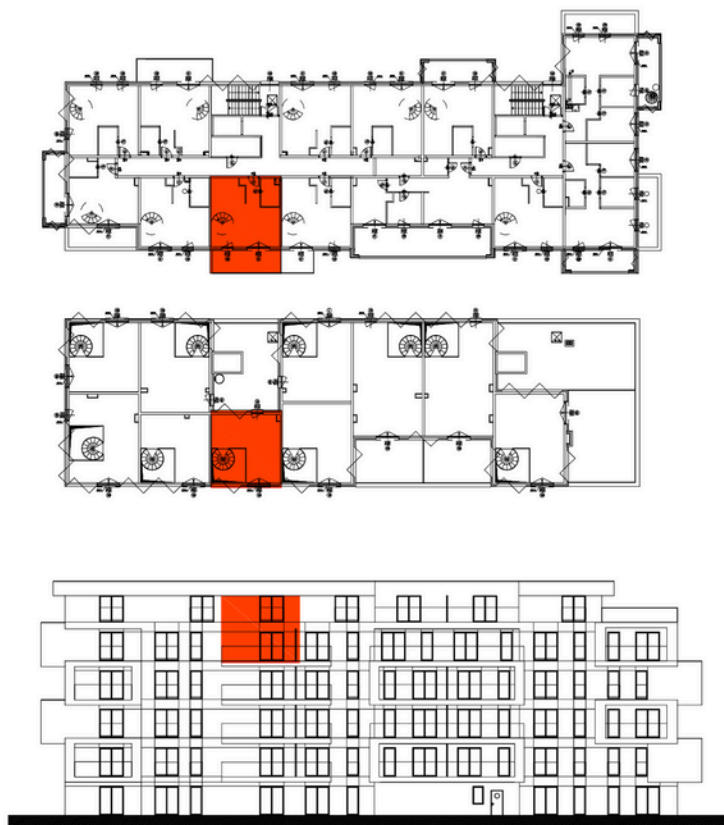

MIESZKANIE NR 43

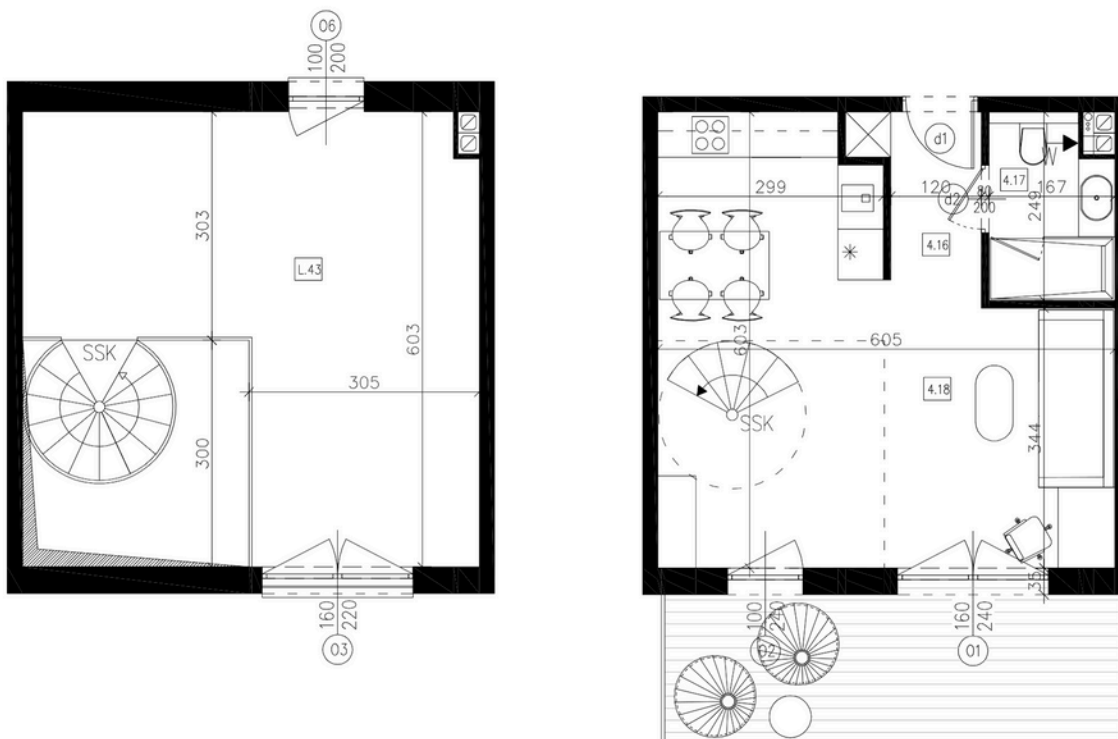

4.16	PRZEDPOKÓJ	3,02	POW. UŻYTKOWA 62,24 M ²
4.17	ŁAZIENKA	3,85	
4.18	SALON Z KUCHNIĄ	28,13	
L_43	ANTRESOLA	27,24	



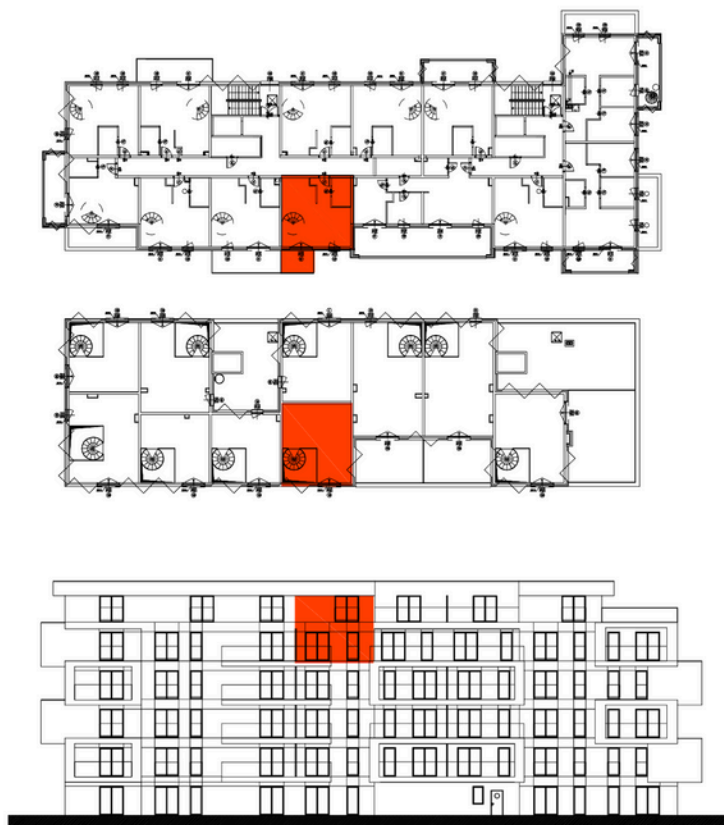

MIESZKANIE NR 44

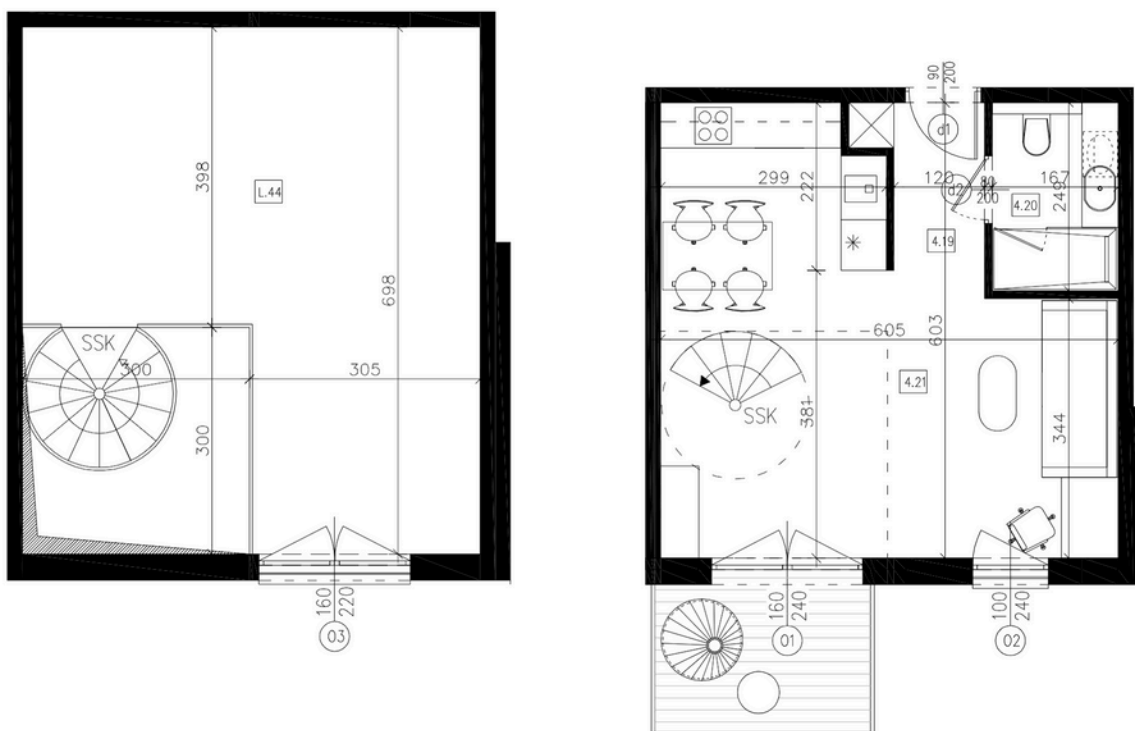

4.19	PRZEDPOKÓJ	3,02	POW. UŻYTKOWA 68,47 M ²
4.20	ŁAZIENKA	4,15	
4.21	SALON Z KUCHNIĄ	28,13	
L_44	ANTRESOLA	33,17	



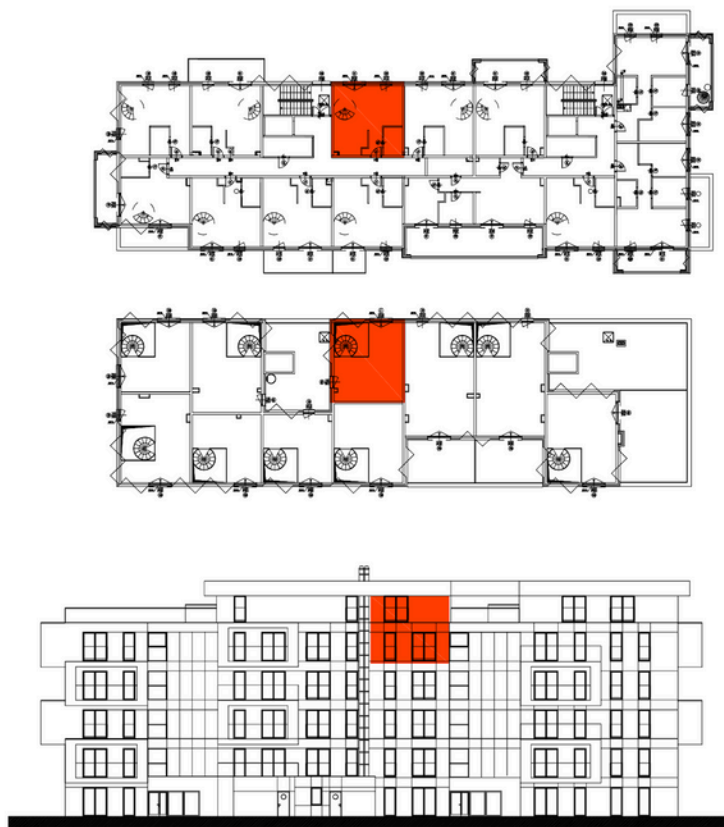

MIESZKANIE NR 45

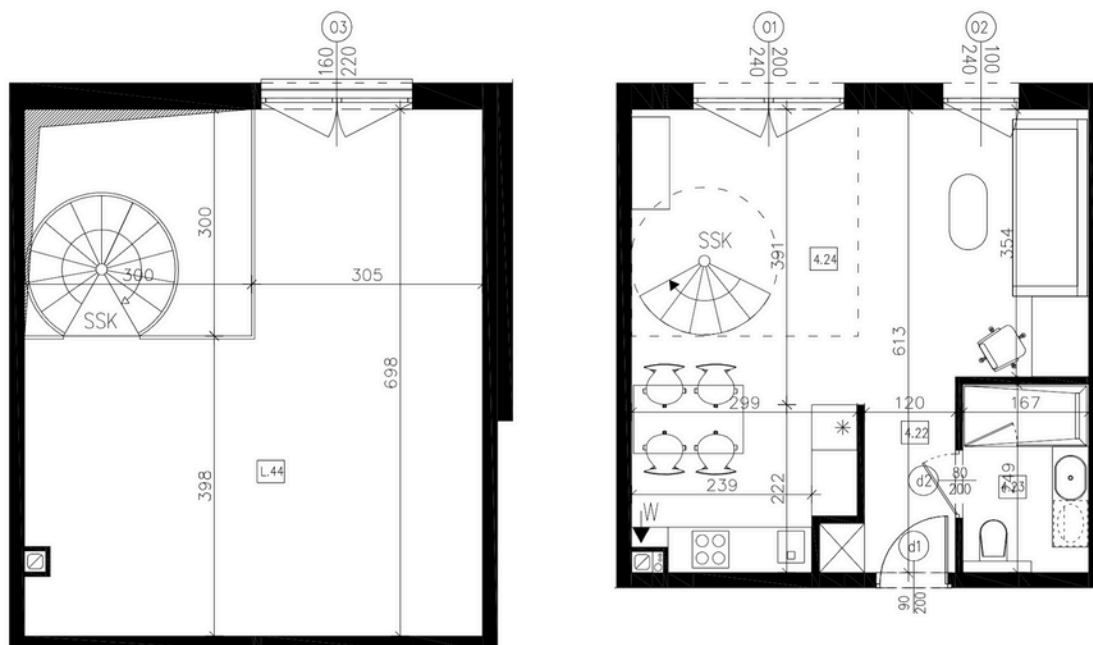

4.22	PRZEDPOKÓJ	3,05	POW. UŻYTKOWA 70,35 M2
4.23	ŁAZIENKA	4,15	
4.24	SALÓN Z KUCHNIĄ	29,98	
L_45	ANTRESOLA	33,17	



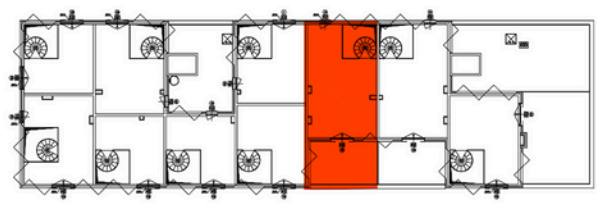
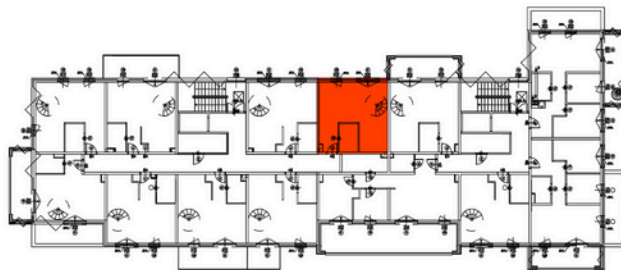

MIESZKANIE NR 46

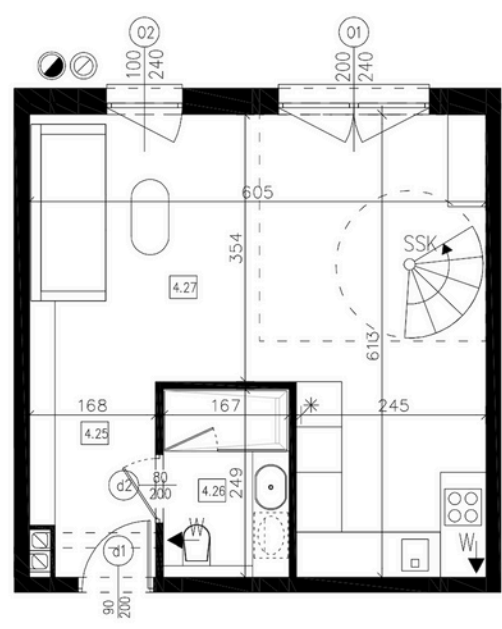
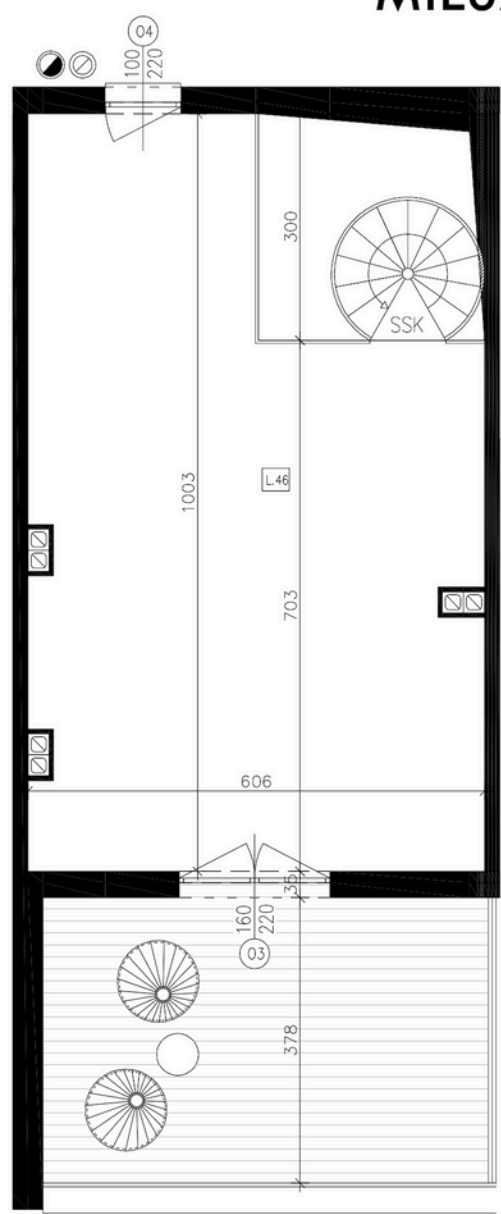

4.25	PRZEDPOKÓJ	4,10	POW. UŻYTKOWA 74,51M2
4.26	ŁAZIENKA	4,15	
4.27	SALON Z KUCHNIĄ	27,89	
L_46	ANTRESOLA	38,37	



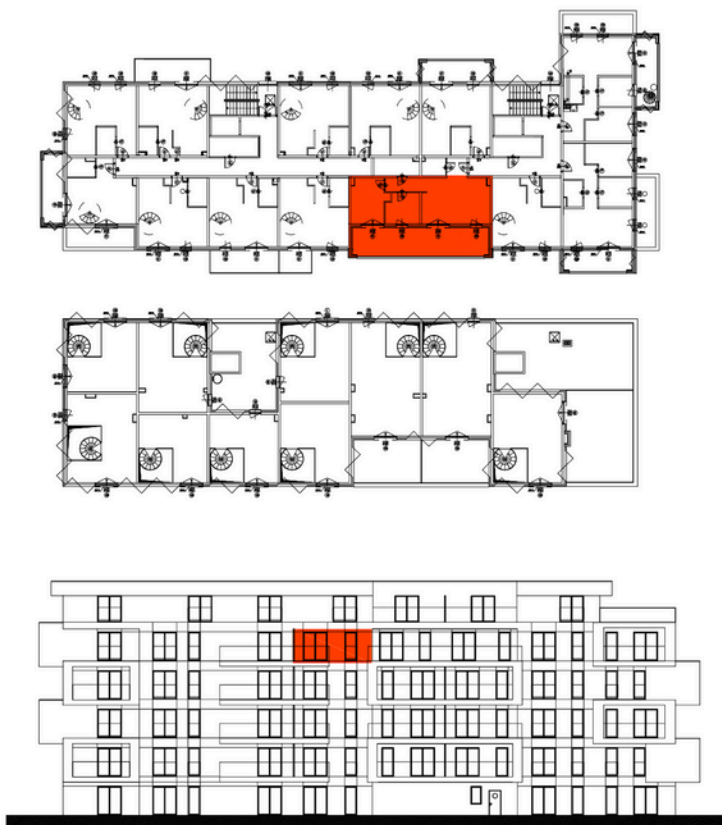

MIESZKANIE NR 47

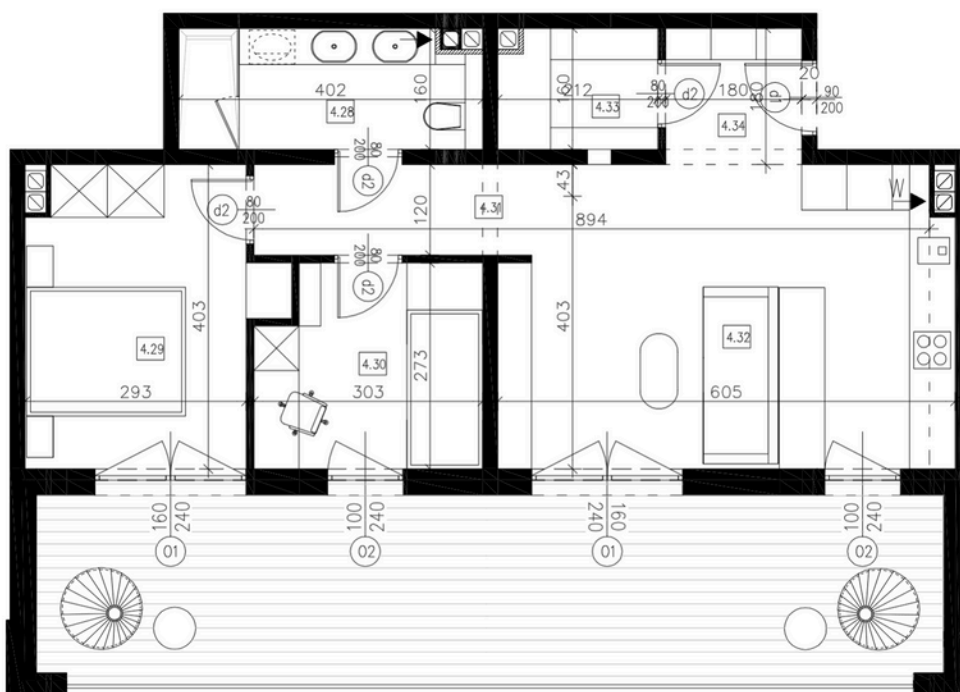

4.28	ŁAZIENKA	6,21	POW. UŻYTKOWA 60,43 M ²
4.29	POKÓJ	11,98	
4.30	POKÓJ	7,74	
4.31	PRZEDPOKÓJ	3,87	
4.32	SALON Z KUCHNIĄ	24,11	
4.33	GARDEROBA	3,28	
4.34	PRZEDPOKÓJ	3,24	



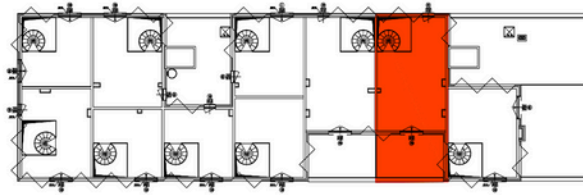
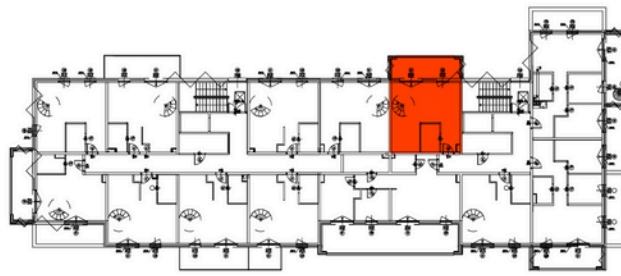

MIESZKANIE NR 48

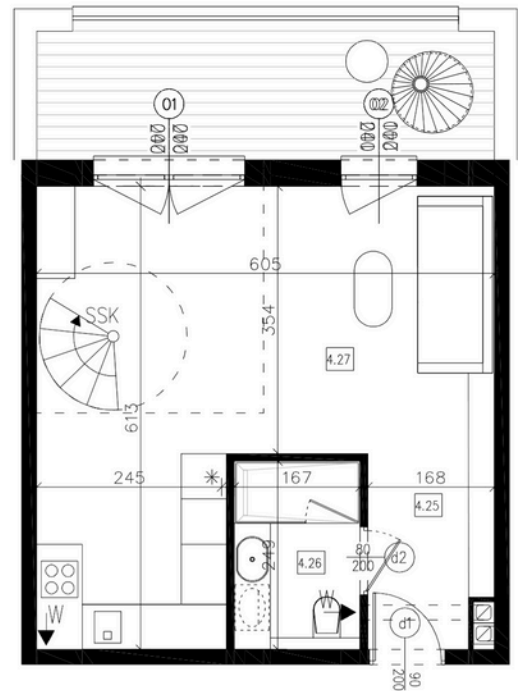
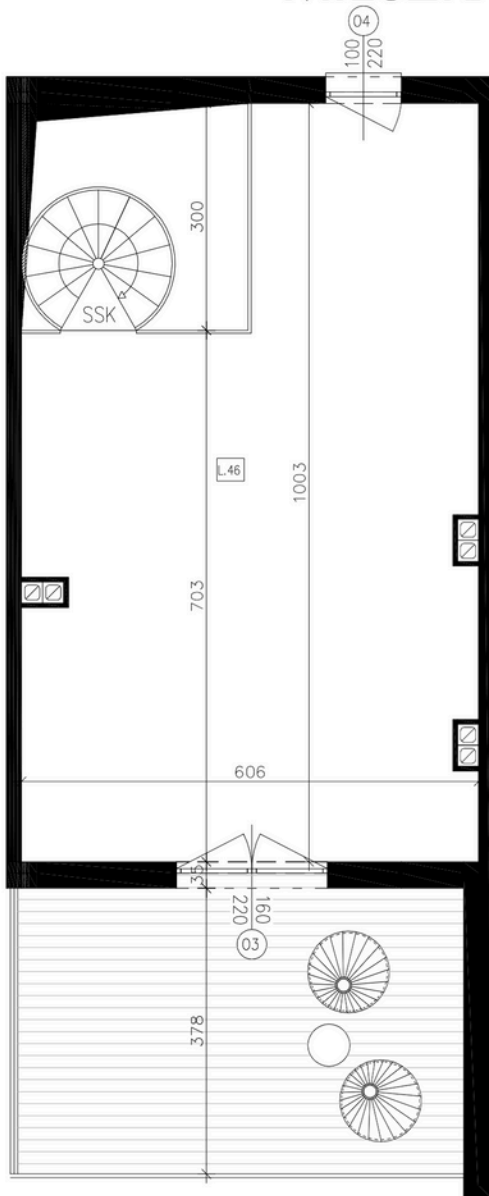

4.25	PRZEDPOKÓJ	4,10	POW. UŻYTKOWA 87,12 M2
4.26	ŁAZIENKA	4,15	
4.27	SALON Z KUCHNIĄ	27,89	
L_46	ANTRESOLA	50,98	



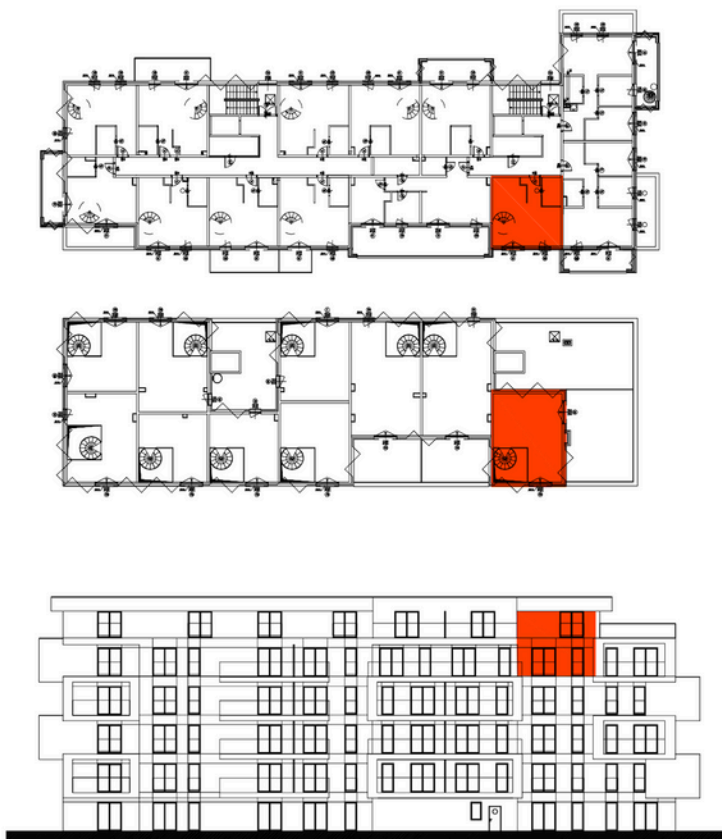

MIESZKANIE NR 49

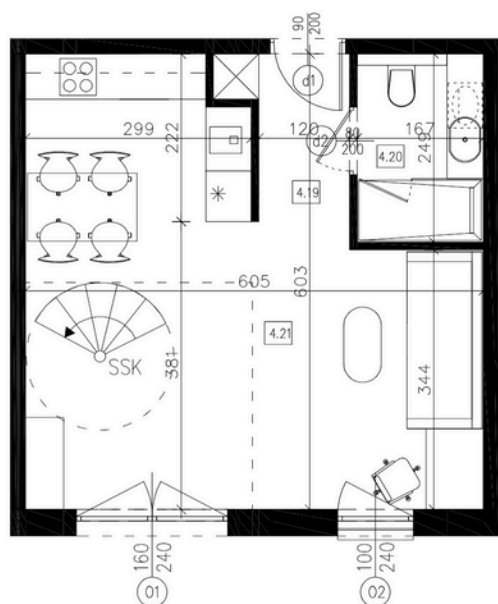
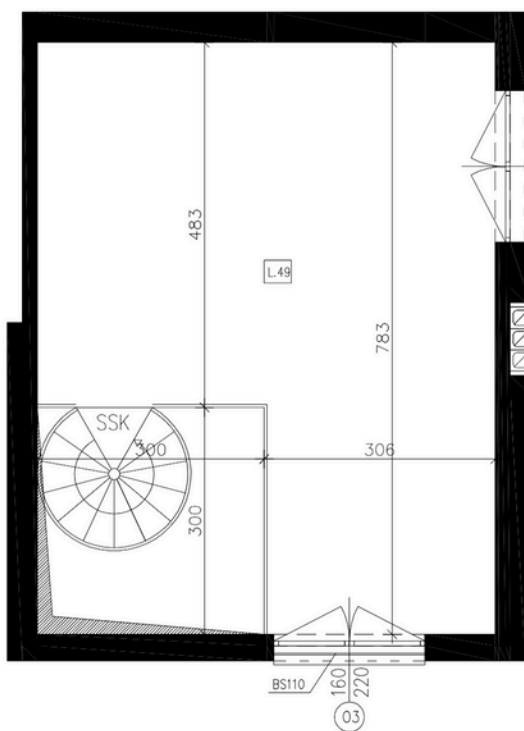

4.19	PRZEDPOKÓJ	3,02	POW. UŻYTKOWA 73,67 M ²
4.20	ŁAZIENKA	4,15	
4.21	SALON Z KUCHNIĄ	28,13	
L_49	ANTRESOLA	38,37	



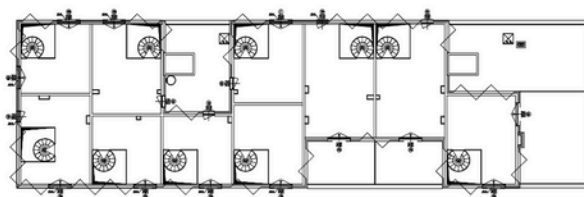
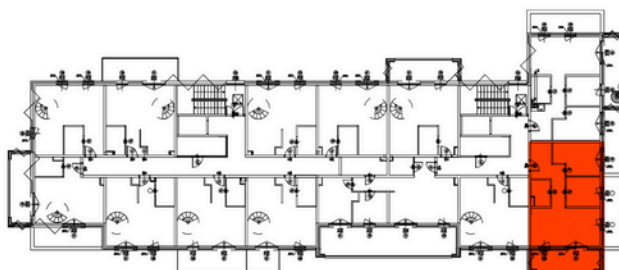

MIESZKANIE NR 50

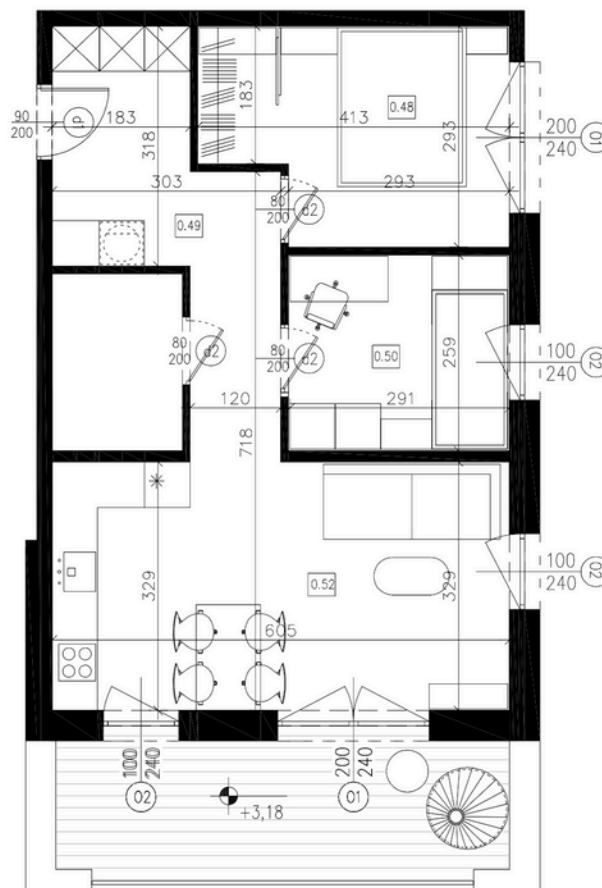

0.43	SALON Z KUCHNIĄ	20,37	POW. UŻYTKOWA 53,37 M2
0.44	ŁAZIENKA	3,73	
0.45	POKÓJ	7,83	
0.46	PRZEDPOKÓJ	10,40	
0.47	POKÓJ	11,04	



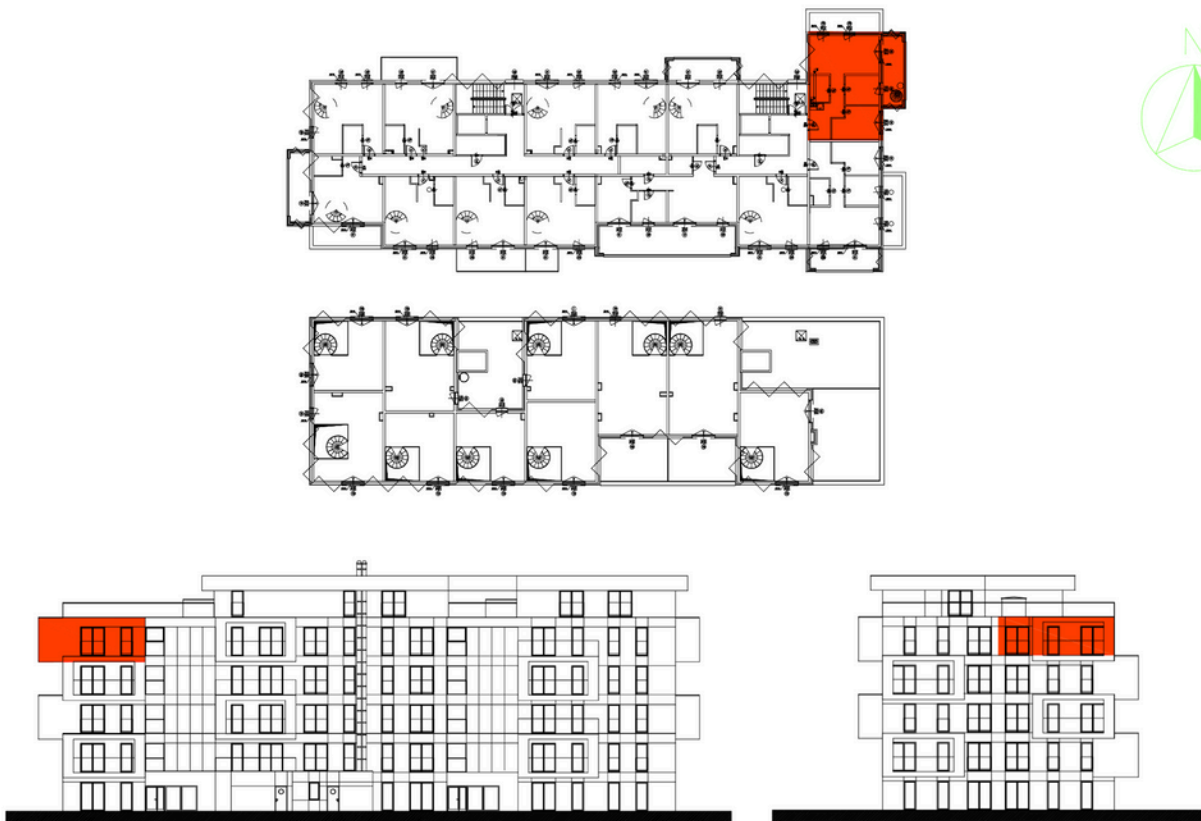

MIESZKANIE NR 51

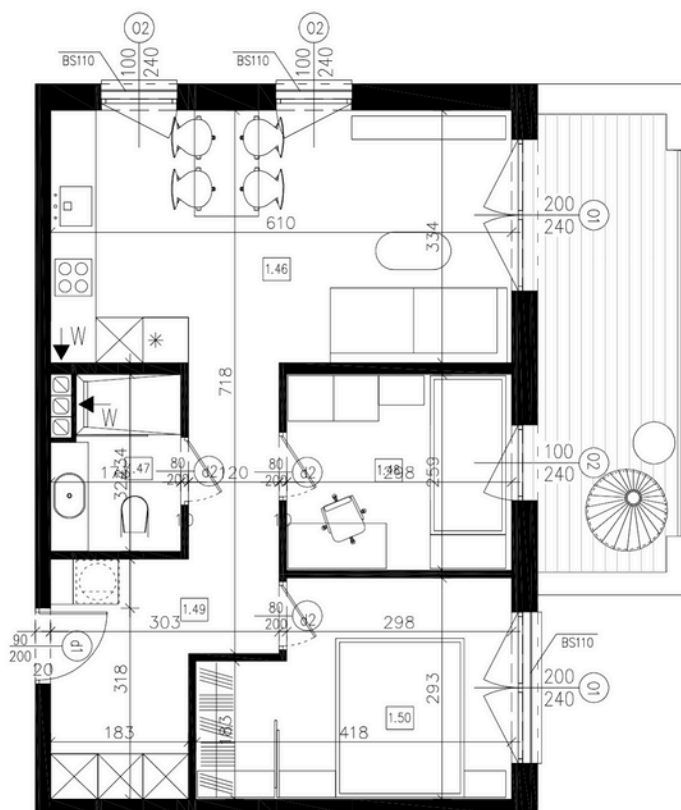

0.48	POKÓJ	11,04	POW. UŻYTKOWA 53,68 M2
0.49	PRZEDPOKÓJ	10,40	
0.50	POKÓJ	7,83	
0.51	ŁAZIENKA	4,04	
0.52	SALON Z KUCHNIĄ	20,37	

